



Orved Vacuum Masters



IDEA 30 – 40
IDEA 31 – 41
IDEA 32 Hi-Line – 42 Hi-Line
**USER AND MAINTENANCE
MANUAL**

SUMMARY

1 SAFETY INSTRUCTIONS AND WARNINGS	5	9.3.1 Parameter settings	37
1.1 INTENDED USE	5	9.3.2 Chef programs operated in containers (<i>Mussel cleaning, Marinade in containers, Pastry bases, Ice cream bases, Meat tenderizing</i>)	38
1.2 CHILDREN	5	9.3.3 Chef programs operated in bags (<i>Powder and spices, Marinade in bags, Sauces, Infusion in bags, Ice cream bases, Meat tenderizing</i>)	40
1.3 TECHNICAL SAFETY	5	9.4 DEGAS CYCLES - PROGRESSIVE VACUUM CYCLE	42
1.4 PROPER USE	6	9.4.1 Parameter settings	43
1.5 CLEANING AND CARE	6	9.4.2 Single step parameter settings	43
2 ADVICES FOR ENVIRONMENTAL PROTECTION	6	9.4.3 Vacuum packing foodstuff using the deaeration cycle (Degas)	44
3 VACUUM MACHINE DESCRIPTION	7	9.5 JAR CYCLES	47
4 TERMS OF USE	7	9.5.1 Editable jar cycle	47
5 BEFORE USING THE VACUUM PACKING MACHINE	10	9.5.2 Parameter settings	47
6 COMMAND PANEL: IDEA 30 - IDEA 40 - IDEA 31 - IDEA 41	10	9.5.3 Containers placed in the vacuum chamber	48
6.1 FUNCTIONS AND WARNINGS	11	9.5.4 Containers external	50
6.1.1 Maximum admissible values	11	9.6 ALARM MANAGEMENT	51
6.1.2 Factory configuration	11	9.6.1 IDEA 30 - 40 e IDEA 31 - 41	51
6.1.3 Activate / deactivate the acoustic signal (idea 30 - 40 - Idea 31 - 41)	11	9.6.2 IDEA 32 HiLine - 42 HiLine	52
6.1.4 Visual alert	12	10 AFTER USE	52
6.1.5 Display of vacuum cycles operated before the oil change	12	11 VACUUM MACHINE CLEANING	52
7 HOW TO OPERATE WITH IDEA 30 - 40 - IDEA 31 - 41	12	11.1 EXTERNAL CLEANING	53
7.1 VACUUM PACKING FOODSTUFF IN BAGS	13	11.2 VACUUM CHAMBER CLEANING	53
7.2 VACUUM PACKING FOODSTUFF IN CONTAINERS	16	11.3 SEALING BAR CLEANING	53
7.2.1 Containers placed in the vacuum chamber	16	11.4 EXTERNAL VACUUM ACCESSORY CLEANING	53
7.2.2 Containers external	18	12 OIL PUMP DEHUMIDIFICATION CYCLE (H2OUT)	53
7.3 VACUUM PACKING FOODSTUFF IN CHANNELLED BAGS, EXTERNALLY	19	12.1 IDEA 30 - 40 - IDEA 31 - 41	54
7.4 DEAERATION CYCLE - PROGRESS VACUUM CYCLE (DEG)	22	12.2 IDEA 32 Hi-Line - 42 Hi-Line	54
8 COMMAND PANEL IDEA 32 Hi-Line - IDEA 42 Hi-Line	25	13 PUMP OIL DATA	56
8.1 VACUUM MACHINE FIRST USE	25	14 SCHEDULED ROUTINE MAINTENANCE	56
8.2 FUNCTIONS AND WARNINGS	26	15 TROUBLESHOOTING	57
8.2.1 Maximum admissible values	26	16 INSTALLATION	59
8.2.2 Factory configuration	27	16.1 SAFETY INSTRUCTIONS	59
9 HOW TO OPERATE WITH IDEA 32 Hi-Line - 42 Hi-Line	27	16.2 INTRODUCTION	59
9.1 ICONS AND PICTOGRAMS	27	16.3 NAMEPLATE DATA	60
9.2 USER CYCLES	29	16.4 TRANSPORT AND HANDLING	61
9.2.1 Editable programs	30	16.5 INSTALLATION	61
9.2.2 Preset programs	32	17 MAINTENANCE	63
9.2.3 Vacuum packing foodstuff in bags	32	17.1 REPLACEMENT OF COMPLETE SEALING BAR	63
9.3 CHEF CYCLES	36	17.2 REPLACEMENT OF TEFLON BAND	64

17.3 ACCESS TO THE MACHINE INTERNAL PART.....	65
17.4 REPLACEMENT OF PUMP OIL.....	66
17.5 REPLACEMENT OF PUMP EXHAUST FILTER	67
17.6 REPLACEMENT OF LID GASKET.....	68
17.7 REPLACEMENT OF UPPER BAR SILICONE.....	69
17.8 REPLACEMENT OF GAS SPRING.....	69
18 WIRING DIAGRAM	71
18.1 IDEA 30 - IDEA 40.....	71
18.2 IDEA 31 - IDEA 41.....	72
18.3 IDEA 32 Hi-Line - IDEA 42 Hi-Line.....	73
19 TECHNICAL DATA.....	74
19.1 IDEA 30 - IDEA 40.....	74
19.2 IDEA 31 - IDEA 41.....	74
19.3 IDEA 32 Hi-Line - IDEA 42 Hi-Line.....	74
20 WARRANTY	75
21 USEFUL NOTES.....	75
22 SPARE PARTS.....	76

1 SAFETY INSTRUCTIONS AND WARNINGS

- This product complies with current safety regulations. Improper use may in any case cause personal injury and/or damage to property.
- This manual is an integral part of the product and provides all indications necessary for correct installation, use and maintenance of the appliance to prevent risks that may cause personal injury and/or damage to property. The manufacturer is not liable for damage resulting from failure to comply with these instructions.
- The user and installer must carefully read and always refer to this manual; Moreover, it must be stored in a well-known and easily accessible place and must be delivered to future users, too.

1.1 INTENDED USE

- The appliance must not be used in outdoor environments.
- The appliance is only intended for the use which it was designed for, i.e. for vacuum packaging foodstuffs.
- All other uses shall be considered improper and potentially hazardous.
- Do not vacuum pack live foods (shellfish and animals in general, etc.).
- This appliance is not suitable to be used by persons with reduced physical, sensory and mental capacities, or inexperienced persons, unless they are supervised and trained regarding use of the appliance by person responsible for their safety. Such persons may only use the appliance without supervision if it has been explained them how to proceed and if they are able to do so in complete safety. It is important they are able to recognise and understand the hazards that may arise from incorrect use of the appliance.

1.2 CHILDREN

- Keep children under the age of eight away from the appliance or under constant supervision.
- Children over the age of eight may only use the appliance without supervision if it has been explained them how to proceed and if they are able to do so in complete safety. It is important that they are able to recognise and understand the hazards that may arise from improper use of the appliance.
- Supervise children who may be nearby the vacuum packaging machine. Do not allow them to play with it.
- Keep children away from the appliance until the sealing bar and sealing line have cooled to prevent the burning risk.
- The packaging material (plastic bags, polystyrene parts, etc.) must be kept out of reach of children as they are potentially dangerous.
- Scrap the appliance in respecting the local standards regarding waste disposal and deliver it to appropriate collection points. Do not leave the appliance unattended, not even for just a few days, as it is potentially dangerous to children.

1.3 TECHNICAL SAFETY

- Poorly executed installation and special maintenance or repairs may expose the user to serious hazards. Ensure these interventions are only performed by qualified personnel authorised by the manufacturer.
- Pay particular attention to the general conditions of the lid (cracks, chips, scratches and deep dents). Any damage may cause an implosion with serious implications for the user.
- Never use the appliance if the lid is damaged.
- The appliance is provided with an oil lubricated vacuum pump. Never tilt or overturn it, to prevent the oil from overflowing.
- Proper operation of the appliance can only be guaranteed if it is connected to legally compliant electrical systems, which totally correspond (voltage, frequency) to the data shown on the appliance data plate. In the case of uncertainty, the system has to be checked by a qualified electrician.
- Electrical safety can only be guaranteed if the appliance is connected to a compliant earthing system. Ensure this essential safety condition is satisfied. In the case of uncertainty, the system has to be checked by a qualified electrician.
- Power strips or extension cords do not guarantee the required safety level (fire hazard). Therefore, do not connect the appliance using these devices.
- Touching or altering electrical or mechanical components may result in injury and equipment failure. Never open the appliance casing.
- Only qualified personnel can operate on the power supply system and access live parts.
- If the power cord is damaged, it must be replaced by an authorised service centre.

- When disconnecting the plug, or if the cord is not provided with plug, make sure the appliance is connected to the electrical mains by a qualified electrician.
- If anomalies are found in the equipment (for example, the power cord is damaged or the control panel is not working properly), do not use the machine and promptly inform your authorised service centre.
- Never use the appliance with wet hands or where there is any contact with water.
- Use suitable work clothes and protection gloves.
- Do not insert objects in the machine vents: risk of electric shock!
- The warranty shall be invalidated in case the vacuum packaging machine is not repaired by an authorised service centre.
- Only replace any faulty or defective parts with original spare parts supplied by your dealer (qualified personnel must replace these parts).
- In the event of a power failure during the vacuum process, the vacuum state is maintained in the chamber and the lid cannot be opened. Never attempt to open the lid by applying force or using tools. Once the electrical power is restored, it will be possible to open the lid again.
- When carrying out special maintenance, installation or repair works, disconnect the appliance from the electrical mains and remove the plug from the outlet. If the plug is not accessible, deactivate the electrical system where the appliance is connected by the main switch. Before performing any repair or installation works, make sure the appliance is disconnected from the mains.
- When the appliance is ready to be scrapped, cut the power cord and remove the lid to make the appliance unusable and make it difficult for children to access the inside of the appliance.

1.4 PROPER USE

- Burning risk! After the bag sealing process, the sealing bar and bag seal itself are very hot. Do not touch the sealing bar or the sealing line immediately after the sealing process.
- Fire hazard! Do not store flammable materials or substances nearby the vacuum packaging machine.
- Any damage to the lid may cause an implosion. Do not place any object on the lid and avoid striking its surface with any object. In the case of accidental impact with the lid, carefully inspect it for damage. If in doubt, contact your authorised service centre.
- Do not use the appliance or lid as a work, support or cutting surface.
- **Always pack foods cooled to +3°C:** this will ensure best preservation results. Moreover, this will prevent the steaming that may affect the vacuum packaging machine operation. In particular, the vacuum pump can be damaged by oxidation resulting from condensed vapors. Monitor the vacuum process carefully and if bubble appear in the liquid, prevent leakage by sealing in advance.
- If liquids reach the pump inlet, they may cause serious damages.
- Before using any type of containers or jars, make sure they are strong enough to withstand the vacuum, even if placed in the fridge, thus preventing an implosion that may be hazardous.
- If the machine is not used for long, it must be switched off removing the plug from the socket (see SCHEDULED ROUTINE MAINTENANCE table at Chapter 14).

1.5 CLEANING AND CARE

- Use only damp cloths and non-aggressive disinfectants and detergents to clean the appliance. Never use sponges or abrasive cloths to prevent damaging the steel surfaces and lid surfaces.
- Water or steam may reach live parts and cause a short circuit. Never use running water or steam cleaning equipment: risk of electric shock!
- The user is responsible for cleaning and routine maintenance. These operations must not be carried out by children without proper supervision.

2 ADVICES FOR ENVIRONMENTAL PROTECTION

1) Packaging:

The packaging materials is 100% recyclable and is marked with the recycling symbol. Follow local waste disposal regulations. The packaging material (plastic bags, polystyrene parts, etc.) must be kept out of reach of children as they are a potentially dangerous.

2) Scrapping/Disposal:

The appliance is made using recyclable materials. This appliance is labelled in compliance with European Directive 2012/19/EU, Waste Electrical and Electronic Equipment (WEEE). By making sure that this appliance is properly scrapped, you are contributing to preventing potential negative consequences to the environment and human health.



If this symbol is used on the appliance or in the accompanying documentation, this means that the product must not be treated as domestic waste and must be delivered to an authorised collection centre for electrical and electronic equipment at the end of its useful life.

When the appliance is ready to be scrapped, cut the power cord and remove the lid to make the appliance unusable and make it difficult for children to enter it.

Scrap the appliance in accordance with local standards regarding waste disposal and deliver it to appropriate collection points. Do not leave the appliance unattended, not even for just a few days, as it is potentially dangerous to children.

For further information regarding the treatment, recovery and recycling of this appliance, contact your local office, waste collection centre or the dealer where the appliance was purchased.

3 VACUUM MACHINE DESCRIPTION

(The model shown in the below image may not exactly correspond to the vacuum packing machine you purchased)

- 1) Machine body
- 2) Lid
- 3) Sealing bar
- 4) Command panel
- 5) Vacuum chamber



4 TERMS OF USE



ELECTRICAL HAZARD! Verify in advance that the voltage indicated on the machine identification plate corresponded to the one of your electric system.

The electrical safety for this appliance is guaranteed only if correctly connected to an efficient earthing system, as required by the current regulations, the manufacturer declines all responsibility for any damage caused by the lack or inefficiency of earthing system.

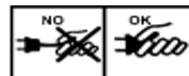

ELECTRICAL HAZARD! Insert and remove the plug from the socket when the machine is switched off only. Do not pull on the cable, but directly on the plug. Access to the live part is allowed to qualified personnel only.



CAUTION! Place the machine on a solid and safe horizontal work surface.

CAUTION! The appliance must be placed in position accessible from all sides. This will ensure the machine the necessary ventilation.

CAUTION! In case the machine is provided with Gas injection system, it is recommended to anchor the gas bottle to the wall. After use, when the machine is off, it is recommended to close the gas bottle and the pressure reducer valve.



WARNING! In appliances provided with gas injection system, IT IS FORBIDDEN TO USE GAS MIX CONTAINING OXYGEN IN A PERCENTAGE HIGHER THAN 21%, OR OTHER EXPLOSIVE AND INFLAMMABLE GASES. The gas mixtures must be adjusted by the supplier at its place, or by authorized technician, at the installation where the machine is used. Supplying and installation of the gas bottle is reserved to supplying company qualified personnel.



WARNING! The vacuum packing machine was designed and projected to operate vacuum in bags and hard containers. The maximum frequency of standard complete vacuum cycles (vacuum and sealing) is 60 seconds.



WARNING! Stop the machine immediately, in case of gas leaks, due to defective or oxidized connections as well as damaged pipes.



Contact the nearest service centre, for immediate replacement of damaged parts.



CAUTION! The room temperature should not fall below than +10°C, to avoid the pump oil thickening, which could compromise the pump functioning.

CAUTION! The pump oil has to be checked constantly, through the sight glass (on the side or on the machine rear panel). The correct oil level is in the range within MINIMUM and MAXIMUM. The colour has to be clear and no turbidity.



CAUTION! VACUUM PUMP OIL, MUST BE REPLACED PERIODICALLY; THE OIL CHANGE FREQUENCY, INCREASE PROPORTIONALLY TO THE VACUUM MACHINE USE. THE OIL MUST BE CHANGED AT LEAST EVERY 5.000 VACUUM CYCLES OPERATED. AT THE OIL CHANGE, THE EXHAUST FILTER MUST BE REPLACED, TOO (see SCHEDULED ROUTINE MAINTENANCE table at Chapter 14).

In case the machine is used to vacuum pack liquids or humid products, the oil and the filter have to be changed more often; in addition, in this case, it is necessary to change oil and filter after an inactivity time longer than one month.

Before an inactivity time longer than two months, operate an oil change.

A whitish and cloudy, or dark and transparent oil colour, means respectively: suction of liquids and humidity, or the oil age. The digital models are provided with oil change signal system. Once the maximum number of cycles has been reached, at the switching on the message "ALL OIL" will appear on the display. The number of vacuum cycles operated, can be detected at any time, using the command panel.

It is really important to operate the pump dehumidification cycle (H2Out) periodically (see chapter 13).



WARNING! DO NOT touch the sealing bars soon after sealing the bags, as they could be still hot.



CAUTION! DO NOT remove the Teflon band covering the sealing bar; Do not use knives or any different sharp tool to remove residuals from sealing bar. Wait for the sealing bar to cool down completely, before any intervention (with not sharp and not pointed tools)



CAUTION! Clean the machine thoroughly after use: use a clean soft cloth moistened with water (do not use any detergent or solvent) to clean the lid. For stainless steel parts, use specific products. Do not use any water jet or steam, which could damage the appliance electric parts.



For any issue may arise (defective functioning or technical assistance) Contact our technical customer service.



5 BEFORE USING THE VACUUM PACKING MACHINE

- Before using the machine, the vacuum chamber and lid must be cleaned using a clean, soft cloth soaked in potable water.
- It is recommended not to use aggressive detergents, stainless steel scrubbers, scrapers or abrasive, acidic or aggressive substances, which may permanently damage the internal surfaces of the vacuum chamber.



6 COMMAND PANEL: IDEA 30 – IDEA 40 – IDEA 31 – IDEA 41

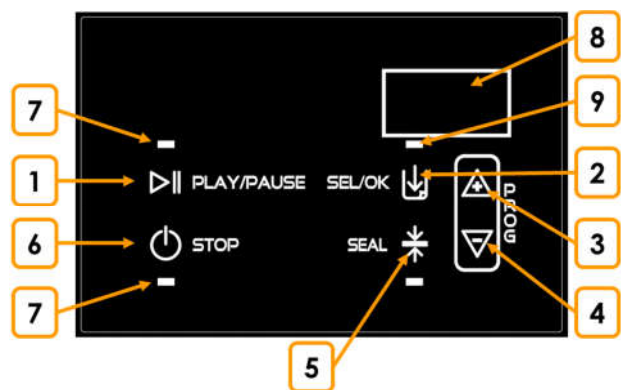

N°	DESCRIPTION
1	<ul style="list-style-type: none"> • Pressed contemporarily with STOP for 4", displays the number of vacuum cycles operated • Pressed contemporarily with STOP at turning on, allows to activate or deactivate the acoustic signal
2	<ul style="list-style-type: none"> • Allows to set the vacuum level, the additional vacuum, Gas (only on IDEA31 - IDEA41) • If pressed after reaching the 90% of vacuum, it allows to anticipate the GAS injection
3	<ul style="list-style-type: none"> • Scroll down the programs • Change the parameters values
4	<ul style="list-style-type: none"> • Pressed contemporarily for 4", allow the saved program reset, restoring the factory values.
5	<ul style="list-style-type: none"> • Allows to set the sealing time • Pressed during the vacuum cycle, allows to anticipate the sealing
6	<ul style="list-style-type: none"> • stand-by/on and on/stand-by (pressed for 5") • Pressed contemporarily with PLAY/PAUSE for 4" displays the number of vacuum cycles operated • Pressed contemporarily with PLAY/PAUSE at turning on, allows to activate or deactivate the acoustic signal • Interrupts the current vacuum cycle
7	<ul style="list-style-type: none"> • Displays the current function
8	<ul style="list-style-type: none"> • Displays the active program • Displays the active function and the set value • Displays any alarm • Displays the vacuum cycles operated before the oil change
9	<ul style="list-style-type: none"> • If ON, indicates that the GAS function is active

6.1 FUNCTIONS AND WARNINGS

6.1.1 Maximum admissible values

FUNCTION	VALORE
VACUUM	10% – 99%
ADDITIONAL VACUUM	1 – 60 sec
SEALING	0,1 – 6,0 sec
GAS (IDEA31- IDEA41)	1 – 90%



CAUTION!

It is necessary to carry out preliminary tests, to identify the optimal percentage of GAS to be injected, for every single product to be packed.

6.1.2 Factory configuration

FUNCTION	VALORE
VACUUM	99
ADDITIONAL VACUUM	5 sec
SEALING	2,5 sec
GAS (IDEA31- IDEA41)	OFF

6.1.3 Activate / deactivate the acoustic signal (per IDEA 30 – 40 - IDEA 31 – 41)

Proceed as described below, to activate or deactivate the acoustic signal:
turn the machine on, pressing contemporarily with **STOP** and **PLAY/PAUSE** buttons.

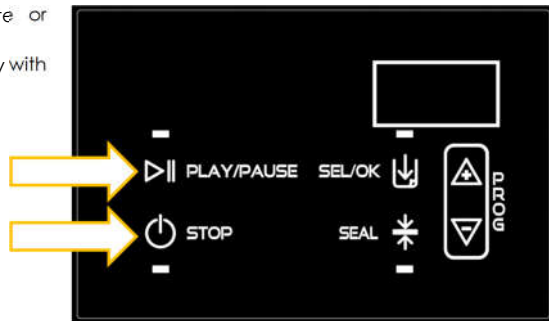

6.1.4 Visual alert



CAUTION!

In case the number of allowed cycles (preset in the machine) has been reached, at every switch-on the machine displays the pump oil change alarm "OIL".

6.1.5 Display of vacuum cycles operated before the oil change

The simultaneous lighting of all LEDs and the **OIL** message on the display, indicate the achievement of the maximum number of vacuum cycles before the pump oil change.

The cycles counter resetting, must be done by an authorized technician after the pump oil change.

Maximum number of vacuum cycles allowed before a pump oil change: 5000

Press contemporarily **STOP** and **PLAY/PAUSE** buttons for 4", to recall the number of vacuum cycles operated.

7 HOW TO OPERATE WITH IDEA 30 - 40 - IDEA 31 - 41



CAUTION!

Pack the product always cold, possibly at 3-4 ° C. The hotter the product, the shorter the shelf life is. You also increase the moisture inside the pump, with consequent oxidation and damage of it.

Preheating of pump oil: If the machine is used only occasionally, please perform at least 2-3 complete CYCLES (VAC 99% AND VAC+ 60") before packaging the products. This allows to pre-heat the oil and the evacuate the water in the pump.







Oil pump dehumidification cycle H2Out. In case the machine is used in the restaurant sector, the H2Out pump cleaning programme should be run every day at the end of the working day. In all other cases, H2Out must be run every week.

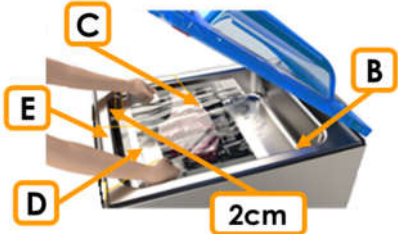

Models with GAS option. Vacuum setting with GAS function active. If the function is activated, the vacuum level must be set at the maximum value. Whether the product still appears as crushed, the Gas percentage must be increased, without modifying the vacuum level! It can be reduced to 95-97%, only to pack stuffed products which could blow up due to the excess of vacuum (stuffed fresh pasta)

At the end of working day, unhook the piston pressing it towards and lower the lid in the rest position. Doing so, the vacuum chamber will be protected from dirt and dust.

7.1 VACUUM PACKING FOODSTUFF IN BAGS

Phase	Description	Image
1	Choose the bag depending on the use (preservation or cooking) best suited to the dimensions of the product: the product should not take more than 2/3 of the bag actual volume. Insert products cooled to +3°C to achieve the best result.	
2	Lift the lid to limit switch and clip the piston, pulling it forward.	
3	Open the lid and make sure the vacuum chamber and product to be packaged are dry. Take care not to dirty or wet the inner part near the bag opening. Place the maximum number of black plates (A) the vacuum chamber can contain, according to the size of the product to be packed.	
4	Keep pressed for 5", to turn the vacuum packing machine on.	

5	<p>Put the vacuum bag (C) containing the product to be packed, in the vacuum chamber (B) and place it centrally on the sealing bar (D). The fringe, no wrinkles, has to overpass the sealing bar about 2cm. Do not bend downwards the bag exceeding the sealing bar.</p> <p>IDEA 31 – 41: in case the gas injection is required, insert the gas nozzle in the bag open part (E).</p>	
6	<p>Select one of the 10 programs P1 – P10, using UP/DOWN buttons.</p>	
7	<p>Press SEL/OK to select the parameter Vacuum and press UP/DOWN to set a value between 10% and 99%.</p> <p>Any vacuum level lower than the maximum, reduces or cancel the preservation effect, due to the residual air remained in the bag.</p>	
8	<p>If the vacuum was set to 99%, then press UP/DOWN buttons again to set the additional vacuum level between 1" and 60".</p>	
9	<p>IDEA 31 – 41: Press SEL/OK button to select GAS parameter and UP/DOWN buttons to set a value between 1% and 90%.</p> <p>When the GAS function is active, make sure that the vacuum level set is 99%.</p>	
10	<p>Press SEAL button to set the sealing time between 0,1" and 6,0", depending to the vacuum bag in use.</p>	

11	<p>Lower the lid using both hands, by pressing on the corners.</p> <p>The vacuum cycle starts automatically.</p>	
12	<p>Press SEL/OK button to switch in advance from Vacuum phase to GAS phase (only on Idea 31 – 41), Press SEL/OK to advance the GAS phase, verifying that the vacuum threshold of 90% was reached. Otherwise, the sealing will be activated. Press SEAL button to switch in advance to sealing.</p>	
13	<p>Pressing STOP button at any time, it is possible to interrupt the vacuum cycle immediately and the vacuum chamber is uncompressed. The lid opens automatically. The machine comes back to the selected program.</p>	
14	<p>End of cycle. The lid opens automatically. Remove the packed products, paying attention not to touch the sealing bar, as it may be still hot.</p>	

In case of packing liquid products, fill the bag **no more one-third** of its volume; if the optional "sloping shelf" is available, adjust it according to the bag size. Turn the machine on and proceed in setting the parameters, as described in the chart above, adjusting the vacuum level, in order to avoid any liquid overflowing.

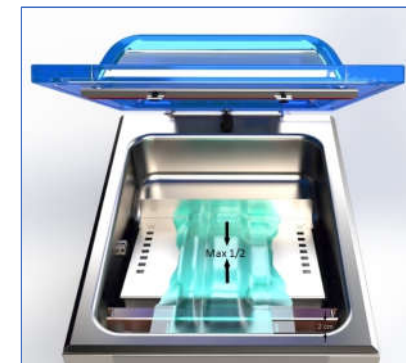
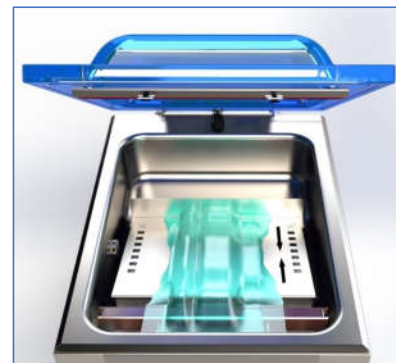

Lower the lid using both hands, by pressing on the corners. The vacuum cycle starts automatically.

7.2 VACUUM PACKING FOODSTUFF IN CONTAINERS



WARNING! Verify that the selected containers were suitable to resist to the vacuum pressure. At the end of working day, unhook the piston pressing it towards and lower the lid in the rest position.

Doing so, the vacuum chamber will be protected from dirt and dust.



CAUTION!

Read carefully the information written at the beginning of Chapter 7.

Choose a container suitable for vacuum packaging

Fill the container with foodstuff and close the lid.

Filling limits:

- Solid products: 100%
- Broths, infusions: 1/2
- Vegetarian and meat sauces: 1/3
- Creams, cream-based sauces: 1/4
- Egg products or egg white: 1/6



Insert products cooled to +3°C to achieve the best result.

Lift the lid to limit switch and clip the piston, pulling it forward.



7.2.1 Containers placed in the vacuum chamber

Phase	Description	Image
1	<p>Open the lid and make sure the vacuum chamber and product to be packaged are dry. Take care not to dirty or wet the inner part.</p> <p>Place the maximum number of black plates (A) the vacuum chamber can contain, according to the size of the product to be packed.</p>	

2	<p>Choose a container suitable for vacuum packaging that fits in the vacuum chamber, which remains at least 1 cm apart from the packaging machine lid once closed. It is possible to remove the sealing bar, if necessary.</p> <p>Make sure that the air intake device be open.</p>	
3	<p>Keep STOP pressed for 5", to turn the vacuum packing machine on.</p>	
4	<p>Press UP/DOWN buttons, to select the Jars (JAR) program.</p>	
5	<p>Press SEL/OK to select the parameter Vacuum and press UP/DOWN to set a value between 10% and 99%.</p>	
6	<p>Lower the lid and PLAY/PAUSE button, to start the vacuum cycle.</p>	
7	<p>Pressing STOP button at any time, it is possible to interrupt the vacuum cycle immediately and the vacuum chamber is uncompressed. The lid opens automatically. The machine comes back to the selected program.</p>	

8	End of cycle. The lid opens automatically. Remove the container from the vacuum chamber.
---	---

7.2.2 Containers external

Phase	Description	Image
1	Place the accessory (A) to operate the vacuum in containers externally, both in the vacuum chamber and on the container lid. Make sure that the air intake device be open.	
2	Keep STOP pressed for 5", to turn the vacuum packing machine on.	
3	Press UP/DOWN button, to select the Jars (JAR) program.	
4	Press SEL/OK to select the parameter Vacuum and press UP/DOWN to set a value between 10% and 99%.	

5	Press PLAY/PAUSE button, to start the vacuum cycle.	
6	Place one end of the suction device on the suction point in the chamber and slightly press the other on the container lid, to start the vacuum.	
7a	In case the vacuum was set at a level lower than 99%, the pump switches off. Remove the accessory and place it on the lid of next container. Press PLAY/PAUSE button, to start a new vacuum cycle.	
7b	In case the vacuum was set at 99%, the pump remains on. Remove the accessory and place it on the lid of next container.	
8	Pressing STOP button at any time, it is possible to interrupt the vacuum cycle immediately.	
9	At the end of the vacuum cycle, remove the accessory from the vacuum chamber.	

7.3 VACUUM PACKING FOODSTUFF IN CHANNELLED BAGS, EXTERNALLY



CAUTION!

To vacuum pack products externally, it is necessary to use channelled vacuum bags (for preservation or for cooking), that can be ordered to the dealer or directly to Orved S.p.A. Pay attention that not all the vacuum bags available on the market are suitable for this use.







At the end of working day, unhook the piston pressing it towards and lower the lid in the rest position. Doing so, the vacuum chamber will be protected from dirt and dust.







CAUTION!

This vacuum packaging procedure is suitable for dry and non sensitive to cushioning foodstuff only

To do this, use the "EASY" accessory for external vacuum.

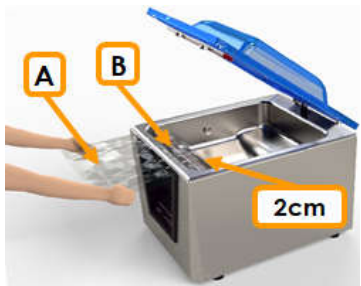

Phase	Description	Image
1	<p>Lift the lid to limit switch and clip the piston, pulling it forward.</p> <p>Open the lid and make sure the vacuum chamber and product to be packaged are dry. Do not remove the fillers from the vacuum chamber.</p> <p>Take care not to dirty or wet the inner part near the bag opening.</p>	
2	<p>Keep  pressed for 5", to turn the vacuum packing machine on.</p>	
3	<p>Select one of the 10 programs P1 – P10, using UP/DOWN buttons.</p>	
4	<p>Press SEL/OK to select the parameter Vacuum and press UP/DOWN to set a value between 10% and 99%.</p> <p>Any vacuum level lower than the maximum, reduces or cancel the preservation effect, due to the residual air remained in the bag.</p>	
5	<p>If the vacuum was set to 99%, then press UP/DOWN buttons again to set the additional vacuum level between 1" and 60".</p>	







6	<p>Press SEL/OK button and choose the parameter GAS and press UP/DOWN buttons, to set the value to OFF</p>	
7	<p>Press SEAL button to set the sealing time between 0,1" and 6,0", depending to the vacuum bag in use.</p>	
8	<p>Choose the channelled vacuum bag, depending on the use (preservation or cooking) best suited to the dimensions of the product: the product should not take more than 2/3 of the bag actual volume.</p> <p>Put the vacuum bag (A) containing the product to be packed centrally on the sealing bar (B). The fringe has to overpass the sealing bar about 2cm.</p> <p>Place the accessory EASY as described on the Kit Easy instructions.</p> <p>Insert products cooled to +3°C to achieve the best result.</p>	
9	<p>Lower the lid, maintaining the channelled bag in horizontal position. The vacuum cycle starts automatically.</p> <p>Interrupt the vacuum cycle, in case you notice any liquid flowing towards the chamber, through the channelled bag</p>	
10	<p>Press SEAL button, to switch in advance from vacuum to sealing phase. IDEA 31 and IDEA 41: Gas injection cannot be used.</p>	
11	<p>Pressing STOP button at any time, it is possible to interrupt the vacuum cycle immediately and the vacuum chamber is uncompressed. The lid opens automatically. The machine comes back to the selected program.</p>	
12	<p>End of cycle. The lid opens automatically. Remove the packed products, paying attention not to touch the sealing bar, as it may be still hot.</p>	







7.4 DEAERATION CYCLE (DEG)

Program which allows to choose a pause and restart for the vacuum phase, as well as for the air re-entering phase, to allow the complete air evacuation from the inside part of the product.

Available on **IDEA 31** and **IDEA 41** only.

Phase	Description	Image
1a	<p>Choose the bag depending on the use (preservation or cooking) best suited to the dimensions of the product: the product should not take more than 2/3 of the bag actual volume. Be careful not to wet or dirty the bag open part.</p> <p>Insert products cooled to +3°C to achieve the best result.</p>	
1b	<p>Choose a container suitable for vacuum packaging that fits in the vacuum chamber, which remains approximately 1 cm from the packaging machine lid once closed. Fill the container with foodstuff and close the lid.</p> <p>Filling limits:</p> <ul style="list-style-type: none"> • Solid products: 100% • Broths, infusions: 1/2 • Vegetarian and meat sauces: 1/3 • Creams, cream-based sauces: 1/4 • Egg products or egg white: 1/6 <p>Insert products cooled to +3°C to achieve the best result.</p>	
2	<p>Lift the lid to limit switch and clip the piston, pulling it forward.</p>	

3	<p>Open the lid and make sure the vacuum chamber and product to be packaged are dry. Take care not to dirty or wet the inner part near the bag opening.</p> <p>Place the maximum number of black plates (A) the vacuum chamber can contain, according to the size of the product or the container to be packed.</p>	
4a	<p>Put the vacuum bag (C) containing the product to be packed, in the vacuum chamber (B) and place it centrally on the sealing bar (D). The fringe has to overpass the sealing bar about 2cm.</p>	
4b	<p>Choose a container suitable for vacuum packaging that fits in the vacuum chamber and remains at least 1 cm apart from the lid closed. It is possible to remove the sealing bar, if necessary.</p> <p>Make sure that the air intake device be open.</p>	
5	<p>Keep  pressed for 5", to turn the vacuum packing machine on.</p>	
6	<p>Select the deaeration program (DEG) UP/DOWN buttons.</p>	
7	<p>Press SEL/OK to select the parameter Vacuum and press UP/DOWN to set a value between 10% and 99%.</p>	

8a	Using a bag , press SEAL button to set the sealing time between 0,1" and 6,0", depending to the vacuum bag in use.	
8b	Using a container , press SEAL button to set the sealing time to 0".	
9	Lower the lid using both hands, by pressing on the corners. The vacuum cycle starts automatically.	
11	Press PLAY/PAUSE button, to pause the vacuum phase (to flat the bubbles appeared into the bag and avoid any product overflowing) and press it again, to have a partial air re-entering and start a new vacuum phase. Multiple time, to achieve Th operation can be repeated multiple time, to obtain – step by step – the vacuum level programmed.	
12a	Press SEAL button to switch in advance to sealing.	
13	Pressing STOP button at any time, it is possible to interrupt the vacuum cycle immediately and the vacuum chamber is uncompressed. The lid opens automatically. The machine comes back to the selected program.	

14a	End of cycle. The lid opens automatically. Remove the packed products, paying attention not to touch the sealing bar, as it may be still hot
14b	End of cycle. The lid opens automatically. Remove the container.

8 COMMAND PANEL IDEA 32 Hi-Line – IDEA 42 Hi-Line

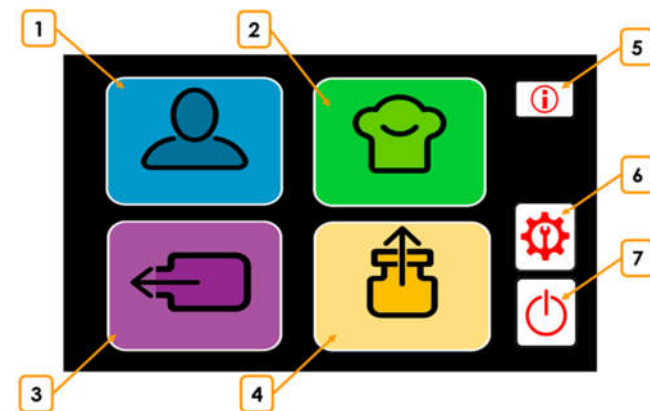

N°	DESCRIPTION
1	User Cycles: completely editable
2	Chef Cycles: special vacuum cycles for special processing
3	Degas Cycles
4	Jar Cycles
5	Shows information about the screen (if available)
6	Gives the access to Technical menu
7	Helps to stop the machine

8.1 VACUUM MACHINE FIRST USE

When first starting up the machine, proceed as described below: Access to technical menu (indicated by number 6 in previous page image).

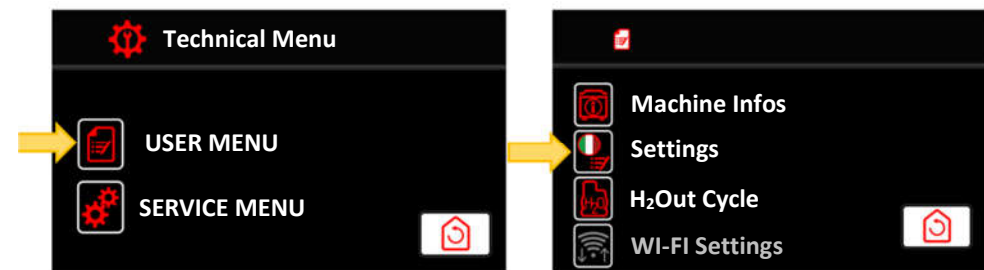

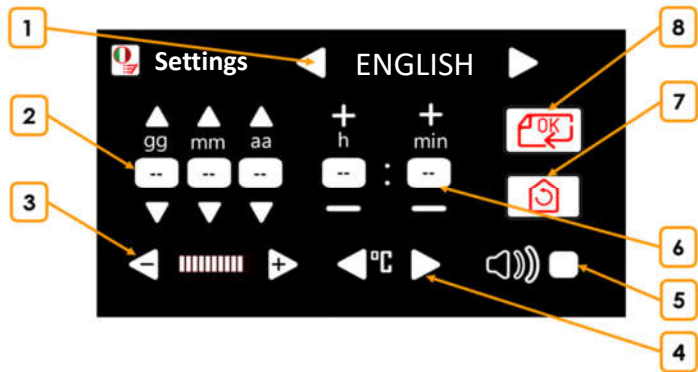

N°	DESCRIPTION
1	Selection of language
2	Set up the date (dd/mm/yyyy)
3	Display brightness regulation
4	Select the temperature measuring unit
5	Buzzer activation
6	Set up the hour (hh:mm)
7	Return to the previous screen, without saving the modified value
8	Save the programmed value and return to the previous screen

8.2 FUNCTIONS AND WARNINGS

8.2.1 Maximum admissible values

FUNCTION		VALUE
	VACUUM	10% ÷ 99%
	ADDITIONAL VACUUM	0 ÷ 60 sec
	GAS INJECTION	0 ÷ 90%
	SEALING	0 ÷ 6 sec
	SOFTAIR	0 ÷ 30 sec
	PAUSE TIME (DEGAS CYCLE)	0 ÷ 60 sec



CAUTION!

It is necessary to carry out preliminary tests, to identify the optimal percentage of GAS to be injected, for every single product to be packed.















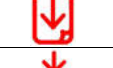
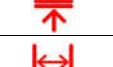

8.2.2 Factory configuration



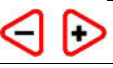

FUNCTION		VALUE
	VACUUM	99%
	ADDITIONAL VACUUM	0 sec
	GAS INJECTION	0%
	SEALING	2,5 sec
	SOFTAIR	0 sec

9 HOW TO OPERATE WITH IDEA 32 Hi-Line - 42 Hi-Line

9.1 ICONS AND PICTOGRAMS

ICON OR PICTOGRAM	DESCRIPTION
	Allows to exit the stand-by and turn the machine on
	Displays the information – if present – about the screen
	To access the Technical menu
	USER CYCLES: Access to editable programs. The user can set the vacuum level, additional vacuum, gas injected, sealing and softair
	USER CYCLES: Access to Preservation preset cycle. To be used for storage of raw or cooked products, solids or liquids not sensitive to crushing
	USER CYCLES: Access to Cooking preset cycle. To be used to vacuum pack – in vacuum cooking bags - all product to be cooked in sous-vide
	USER CYCLES: Access to Vacuum + Gas Min preset cycle. To be used to vacuum pack products to be protected from crushing, thanks to 30% injection of GAS

ICON OR PICTOGRAM	DESCRIPTION
	USER CYCLES: Access to Vacuum + Gas Med preset cycle. To be used to vacuum pack products to be protected from crushing, thanks to 40% injection of GAS
	USER CYCLES: Access to Vacuum + Gas Max preset cycle. To be used to vacuum pack products to be protected from crushing, thanks to 50% injection of GAS
	USER CYCLES: Access to External vacuum (in channelled bags) preset cycle. To be used to vacuum pack, in channelled vacuum bags, solid products which size exceeds the chamber size
	USER CYCLES: Access to Only sealing preset cycle. To be used to operate only sealing in vacuum bags.
	Scroll through the list of cycles
	Vacuum parameter setting
	Additional vacuum parameter setting
	Gas injection parameter setting
	Sealing parameter setting
	Softair parameter setting
	Stop the vacuum cycle in advance
	To access the parameter settings menu
	Return to the previous screen
	Pressed for 5", allows to activate the printing function (optional)
	Return to the previous screen without saving the programmed parameters
	Allows to increase or decrease the values of set parameters
	Name the program
	Save the parameters settings and come back to previous screen.
	Copy a program

ICON OR PICTOGRAM	DESCRIPTION
	Delete a program
	JAR CYCLES: Access to editable programs. The user can set the required vacuum level.
	JAR CYCLES: Access to JAR Min preset cycle. To be used to re-pack screw cap jars. Only cap sealing
	JAR CYCLES: Access to JAR MED preset cycle. To be used to operate partial vacuum in professional containers, implosion resistant; for foodstuff to be pasteurized or sterilized.
	JAR CYCLES: Access to JAR MAX preset cycle. To be used to operate maximum vacuum in professional containers

9.2 USER CYCLES

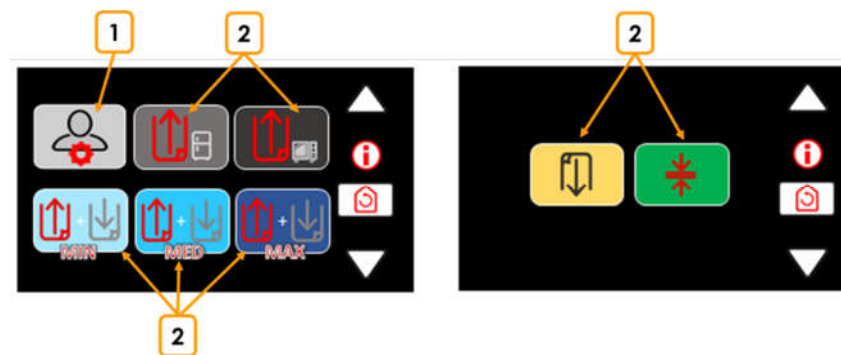

N°	Description
1	Access to editable programs
2	Access to preset user programs

9.2.1 Editable programs

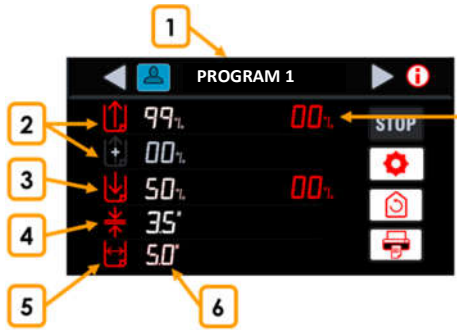

N°	Description
1	Program name
2	Access to Vacuum and Additional Vacuum parameter settings menu
3	Access to setting parameters menu Anticipate the GAS injection (once at least the 90% vacuum was reached)
4	Access to setting parameters menu Anticipate the sealing
5	Access to setting parameters menu Anticipate the Softair
6	Display set value
7	Instant value reached in the phase

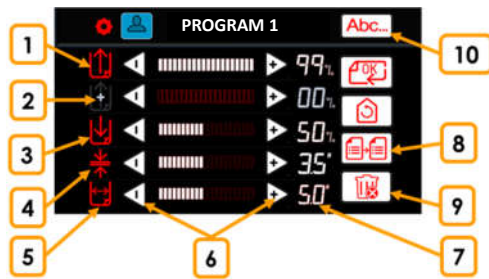

Phase	Description	Image
1	Vacuum percentage Allows to enter in Vacuum and Additional Vacuum setting menu	
2	Duration of Additional Vacuum Allows to enter in Vacuum and Additional Vacuum setting menu	
3	Percentage of injected Gas Allows to enter in Gas injection setting menu	

4	Sealing time duration Allows to enter in Sealing time setting menu	
5	Softair Duration (slow air return) Allows to enter in Softair duration setting menu	
6	Increase or reduce the parameter values	
7	Set value	
8	Copy the program	
9	Delete the program	
10	Name the program	

9.2.2 Preset programs

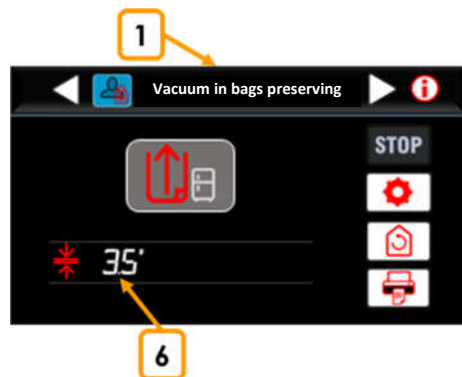

N°	Description
1	Preset program name
2	Editable parameter – Set value

9.2.3 Vacuum packing foodstuff in bags



CAUTION!

Pack the product always cold, possibly at 3-4 ° C. The hotter the product, the shorter the shelf life is. You also increase the moisture inside the pump, with consequent oxidation and damage of it.





Pre-heating of pump oil: If the machine is used only occasionally, please perform at least 2-3 complete USER CYCLES (VAC 99% AND VAC+ 60") before packaging the products. This allows to pre-heat the oil and the evacuate the water in the pump.



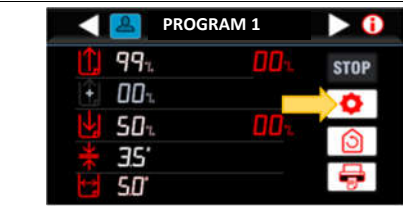
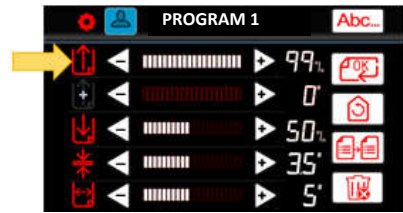

Oil pump dehumidification cycle H2Out. In case the machine is used in the restaurant sector, the H2Out pump cleaning programme should be run every day at the end of the working day. In all other cases, H2Out must be run every week.

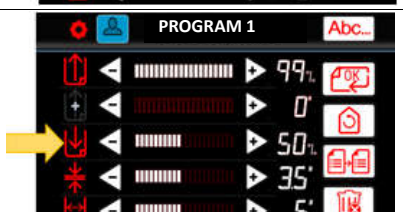

Models with GAS option. Vacuum setting with GAS function active. If the function is activated, the vacuum level must be set at the maximum value. Whether the product still appears as crushed, the Gas percentage must be increased, without modifying the vacuum level! It can be reduced to 95-97%, only to pack stuffed products which could blow up due to the excess of vacuum (stuffed fresh pasta)

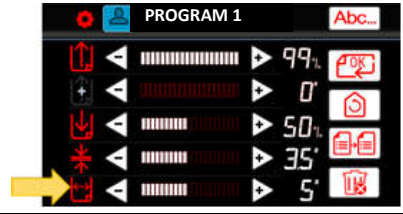
At the end of working day, unhook the piston pressing it towards and lower the lid in the rest position. Doing so, the vacuum chamber will be protected from dirt and dust.

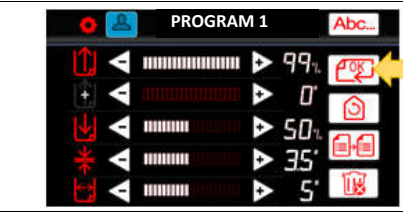
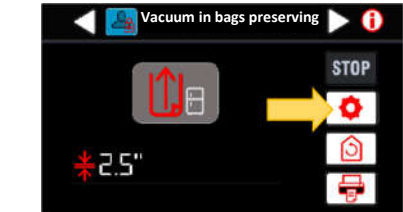
Phase	Description	Image
1	Choose the bag depending on the use (preservation or cooking) best suited to the dimensions of the product: the product should not take more than 2/3 of the bag actual volume. Insert products cooled to +3°C to achieve the best result.	
2	Lift the lid to limit switch and clip the piston, pulling it forward.	
3	Open the lid and make sure the vacuum chamber and product to be packaged are dry. Take care not to dirty or wet the inner part near the bag opening. Place the maximum number of black plates (A) the vacuum chamber can contain, according to the size of the product to be packed.	
4	Activate the command panel by <u>double quick touch</u> on the screen. Press the STAND-BY button, to turn the machine on.	
5	Put the vacuum bag (C) containing the product to be packed, in the vacuum chamber (B) and place it centrally on the sealing bar (D). The fringe, no wrinkles, has to overpass the sealing bar about 2cm. Do not bend downwards the bag exceeding the sealing bar. In case the gas injection is required, insert the gas nozzle in the bag open part (E).	



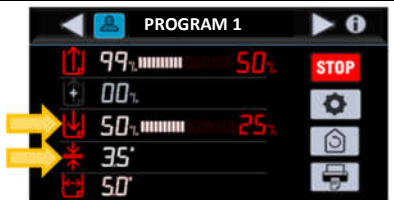



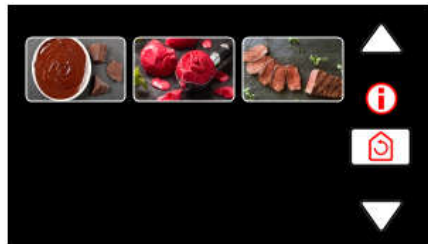

6	Select User Cycles	
7	Select the desired program, choosing between the editable and preset programs available.	
8a	In case of an editable cycle , press SETTINGS .	
8a.1	Press +/- buttons, to set a vacuum level from 10% to 99% Any vacuum level lower than the maximum, reduces or cancel the preservation effect, due to the residual air remained in the bag.	
8a.2	Press +/- buttons, to set an additional vacuum time from 1" to 60"	
8a.3	Press +/- buttons, to set a GAS level from 1% to 90% When the GAS function is active, make sure that the vacuum level set is 99%.	
8a.4	Press +/- buttons, to set a sealing time from 0" to 6"	

8a.5	Press +/- buttons, to set a softair time from 0" to 30"	
8a.6	Name the program	
8a.7	Press OK to save the set parameters and come back to the previous screen	
8b	If one of the preset cycles Vacuum in bag preserving Vacuum in bag cooking is used (Example: Vacuum in bag preserving), only the parameter sealing time can be edited.	
8c	If one of the preset cycles Vacuum + GAS MIN Vacuum + GAS MED Vacuum + GAS MAX (Example: Vacuum + GAS MED), all the parameters can be edited, but it is necessary to make a copy of the program, to save the new settings.	
9	Lower the lid using both hands, by pressing on the corners. The vacuum cycle starts automatically.	

10	<p>Press the correspondent button icon on the display, to switch in advance from Vacuum phase to GAS phase, or to anticipate the Sealing.</p> <p>To advance the GAS phase, verify that the vacuum threshold of 90% was reached. Otherwise, the sealing will be activated.</p>	
11	<p>Pressing STOP button at any time, it is possible to interrupt the vacuum cycle immediately and the vacuum chamber is uncompressed. The lid opens automatically. The machine comes back to the selected program.</p>	
12	<p>End of cycle. The lid opens automatically. Remove the packed products, paying attention not to touch the sealing bar, as it may be still hot</p>	

9.3 CHEF CYCLES



	Program name		
	Mussels cleaning		Sauces
	Powders and spices		Infusions in bag
	Marinade in bags		Creme and pastry bases
	Marinade in containers		Ice cream bases
	Meat tenderizing		

9.3.1 Parameter settings

(Example program: Marinade in bags)

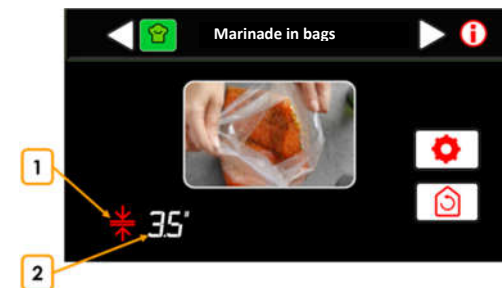









N°	Description	
1	Enter the sealing time setting menu (if available)	
2	Display the sealing time (if available) Enter the sealing time setting menu (if available) Anticipate the sealing phase (if available)	





1	Step progress display bar
2	Phase progress display bar

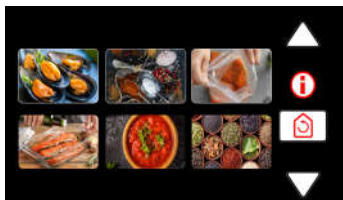



9.3.2 Chef programs operated in containers (Mussel cleaning, Marinade in containers, Pastry bases, Ice cream bases, Meat tenderizing)

Phase	Description	Image
1	<p>Choose a container suitable for vacuum packaging that fits in the vacuum chamber, which remains approximately 1 cm from the packaging machine lid once closed. Fill the container with foodstuff and leave it without lid.</p> <p>Filling limits:</p> <ul style="list-style-type: none"> • Solid products: 100% • Broths, infusions: 1/2 • Vegetarian and meat sauces: 1/3 • Creams, cream-based sauces: 1/4 • Egg products or egg white: 1/6 <p>Insert products cooled to +3°C to achieve the best result.</p>	
<p><i>In case the product need to be STORED and PRESERVED or COOKED after the Chef Cycle, complete the process vacuum packing it. The product must remain cooled at +3°C at all stages</i></p>		
2	<p>Lift the lid to limit switch and clip the piston, pulling it forward.</p>	
3	<p>Open the lid and make sure the vacuum chamber and product to be packaged are dry.</p> <p>Place the maximum number of black plates (A) the vacuum chamber can contain, according to the size of the product to be packed.</p>	

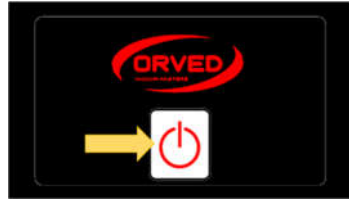
4	<p>Choose a container suitable for vacuum packaging that fits in the vacuum chamber and remains at least 1 cm apart from the lid closed.</p> <p>It is possible to remove the sealing bar, if necessary.</p> <p>Make sure that the air intake device be open.</p>	
5	<p>Activate the command panel by <u>double quick touch</u> on the screen.</p> <p>Press the STAND-BY button, to turn the machine on.</p>	
6	<p>Select Chef Cycles</p>	
7	<p>Select the desired Chef program (Example: Mussels cleaning)</p>	
8	<p>Lower the lid using both hands, by pressing on the corners.</p> <p>The vacuum cycle starts automatically.</p>	
9	<p>Pressing STOP button at any time, it is possible to interrupt the vacuum cycle immediately and the vacuum chamber is uncompressed. The lid opens automatically. The machine comes back to the selected program.</p>	
10	<p>End of cycle. The lid opens automatically. Remove the container.</p>	

9.3.3 Chef programs operated in bags (Powder and spices, Marinade in bags, Sauces, Infusion in bags, Ice cream bases, Meat)

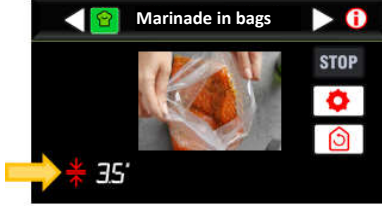
Phase	Description	Image
1	Choose the bag depending on the use (preservation or cooking) best suited to the dimensions of the product: the product should not take more than 2/3 of the bag actual volume. Insert products cooled to +3°C to achieve the best result.	
2	Lift the lid to limit switch and clip the piston, pulling it forward.	
3	Open the lid and make sure the vacuum chamber and product to be packaged are dry. Take care not to dirty or wet the inner part near the bag opening. Place the maximum number of black plates (A) the vacuum chamber can contain, according to the size of the product to be packed.	
4	Activate the command panel by <u>double quick touch</u> on the screen. Press the STAND-BY button, to turn the machine on.	

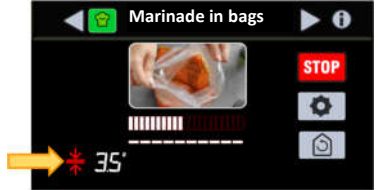
5	Put the vacuum bag (C) containing the product to be packed, in the vacuum chamber (B) and place it centrally on the sealing bar (D). The fringe, no wrinkles, has to overpass the sealing bar about 2cm. Do not bend downwards the bag exceeding the sealing bar.	
6	Select Chef Cycles	
7	Select the desired Chef program (Example: Marinade in bag)	
8	It is possible to modify the sealing time, pressing the correspondent button on the display.	
8	Lower the lid using both hands, by pressing on the corners. The vacuum cycle starts automatically.	
9	Press the correspondent icon on the display, to switch in advance from Vacuum phase to Sealing phase.	

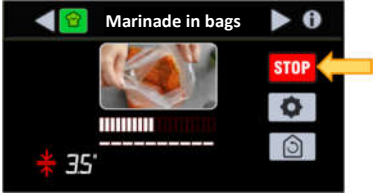
10	Pressing STOP button at any time, it is possible to interrupt the vacuum cycle immediately and the vacuum chamber is uncompressed. The lid opens automatically. The machine comes back to the selected program.	
11	End of cycle. The lid opens automatically. Remove the packed products, paying attention not to touch the sealing bar, as it may be still hot	

9.4 DEGAS CYCLES - PROGRESSIVE VACUUM CYCLES

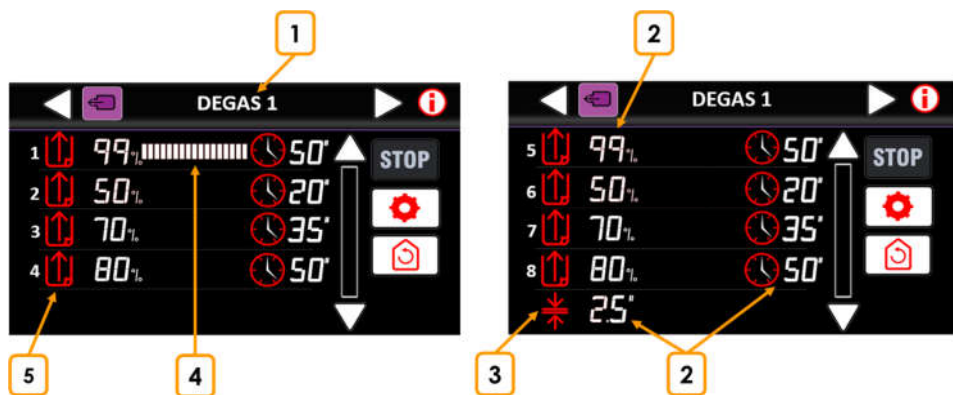

N°	Description
1	Cycle name: from DEGAS 1 to DEGAS 5
2	Set value
3	Enter the sealing time setting menu Anticipate the sealing
4	Phase progress display bar
5	Enter the single step setting menu (vacuum and pause)

9.4.1 Parameter settings

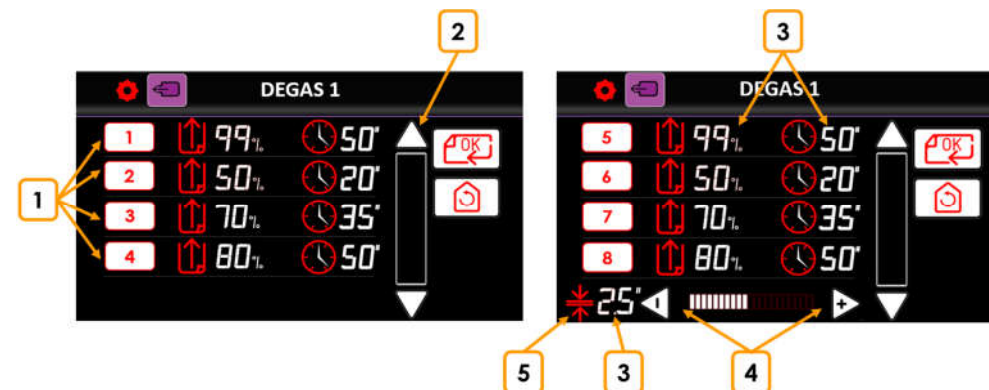

N°	Description
1	Allows to activate the step (button becomes white) and to enter the vacuum setting menu and step pause
2	Allow to switch from step 1 to 8 and vice versa
3	Set value
4	Allows to modify the sealing time
5	Allows to enter the sealing time setting menu

9.4.2 Single step parameter settings

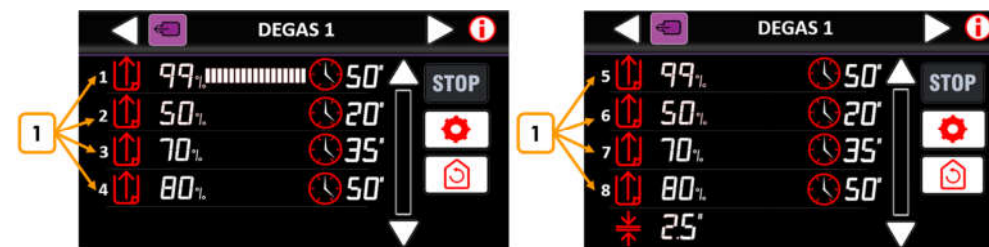

N°	Description
1	Allows to enter the vacuum setting menu and step pause







9.4.3 Vacuum packing foodstuff using the deaeration cycle (Degas)

Vacuum cycle in several phases, which alternates vacuum and pause to allow the total air suction from the inside part of the product.

Phase	Description	Image
1a	Choose the bag depending on the use (preservation or cooking) best suited to the dimensions of the product: the product should not take more than 2/3 of the bag actual volume. Insert products cooled to +3°C to achieve the best result.	
1b	Choose a container suitable for vacuum packaging that fits in the vacuum chamber, which remains at least 1 cm apart from the packaging machine lid once closed. Fill the container with foodstuff and close the lid. Filling limits: <ul style="list-style-type: none"> • Solid products: 100% • Broths, infusions: 1/2 • Vegetarian and meat sauces: 1/3 • Creams, cream-based sauces: 1/4 • Egg products or egg white: 1/6 Insert products cooled to +3°C to achieve the best result.	
2	Lift the lid to limit switch and clip the piston, pulling it forward.	

3	Make sure the vacuum chamber and product to be packaged are dry. Take care not to dirty or wet the inner part near the bag opening. Place the maximum number of black plates (A) the vacuum chamber can contain, according to the size of the product or the container to be packed.	
4a	Put the vacuum bag (C) containing the product to be packed, in the vacuum chamber (B) and place it centrally on the sealing bar (D). The fringe has to overpass the sealing bar about 2cm.	
4b	Choose a container suitable for vacuum packaging that fits in the vacuum chamber. It is possible to remove the sealing bar, if necessary. Make sure that the air intake device be open.	
5	Activate the command panel by <u>double quick touch</u> on the screen. Press the STAND-BY button, to turn the machine on.	
6	Select Degas Cycles	
7	Press SETTINGS button or one of the icons to edit the parameter of every step. Press the correspondent icon to modify the sealing time, if necessary.	

8	<p>Press the icon corresponding to the step, to enter the setting screen and edit the parameter values. Press + / - buttons to set the SEALING TIME from 0" to 6,0". Press OK to save the new set values and come back to the previous screen.</p>	
9	<p>Press +/- buttons, to set a vacuum level from 10% to 99% Press +/- buttons, to set a STEP PAUSE TIME from 0" to 60". Set the Softair air return time</p>	
10	<p>To deactivate a step: press the button corresponding to the step to be deactivated (it will change from white to black) and press OK to save the changes and come back to the previous screen.</p>	
11	<p>Lower the lid using both hands, by pressing on the corners. The vacuum cycle starts automatically.</p>	
12	<p>Pressing STOP button at any time, it is possible to interrupt the vacuum cycle immediately and the vacuum chamber is uncompressed. The lid opens automatically. The machine comes back to the selected program.</p>	
13a	<p>End of cycle. The lid opens automatically. Remove the packed products, paying attention not to touch the sealing bar, as it may be still hot</p>	
13b	<p>End of cycle. The lid opens automatically. Remove the container.</p>	

9.5 JAR CYCLES

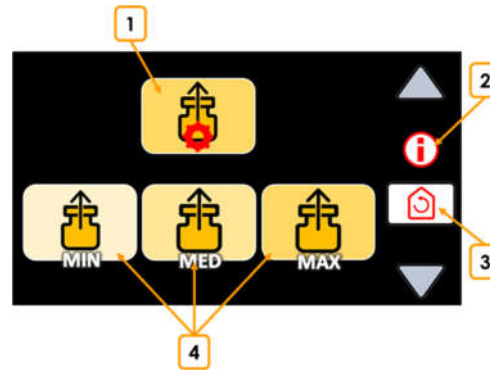

N°	Description
1	Editable JAR Cycle
2	Preset JAR Cycles

9.5.1 Editable jar cycle

N°	Description
1	Program name
2	Instant value in the cycle
3	Set value

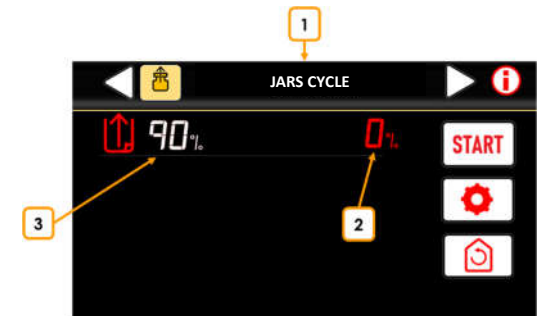

9.5.2 Parameter settings

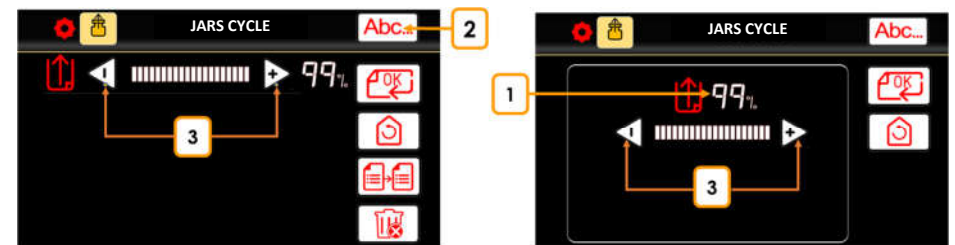

N°	Description
1	Set vacuum percentage
2	Name the program
3	Modify the vacuum percentage

Choose a container suitable for vacuum packaging.

Fill the container with foodstuff and close the lid.

Filling limits:

- Solid products: 100%
- Broths, infusions: 1/2
- Vegetarian and meat sauces: 1/3
- Creams, cream-based sauces: 1/4
- Egg products or egg white: 1/6



Insert products cooled to +3°C to achieve the best result.

Lift the lid to limit switch and clip the piston, pulling it forward.





9.5.3 Containers placed in the vacuum chamber

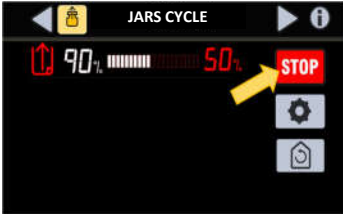

Phase	Description	Image
1	Make sure the vacuum chamber and product to be packaged are dry. Take care not to dirty or wet the inner part. Place the maximum number of black plates (A) the vacuum chamber can contain, according to the size of the product to be packed.	

2	Choose a container suitable for vacuum packaging that fits in the vacuum chamber, which remains at least 1 cm apart from the packaging machine lid once closed. It is possible to remove the sealing bar, if necessary. Make sure that the air intake device be open.	
3	Activate the command panel by <u>double quick touch</u> on the screen. Press the STAND-BY button, to turn the machine on.	
4	Select JARS Cycles	
5	Select the desired program choosing between: Editable Cycle , MIN Level , MED Level , MAX Level .	
6	Lower the lid using both hands, by pressing on the corners.	
7a	In case an Editable Cycle is chosen, set the required vacuum level, then press START to start it.	
7b	In case a Preset Cycle (MIN Level , MED Level , MAX Level) is chosen, press START to start it.	

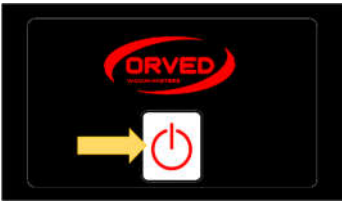
8	Pressing STOP button at any time, it is possible to interrupt the vacuum cycle immediately and the vacuum chamber is uncompressed. The lid opens automatically. The machine comes back to the selected program.	
9	End of cycle. The lid opens automatically. Remove the container.	

9.5.4 Containers external

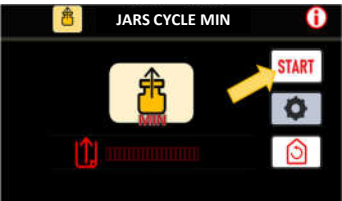
Phase	Description	Image
1	Place the accessory (A) to operate the vacuum in containers externally, both in the vacuum chamber and on the container lid. Make sure that the air intake device be open.	
		
2	Activate the command panel by <u>double quick touch</u> on the screen. Press the STAND-BY button, to turn the machine on.	
3	Select Jars Cycles.	
4	Select the desired program choosing between: Editable Cycle , MIN Level , MED Level , MAX Level .	

5a	In case an Editable Cycle is chosen, set the required vacuum level, then press START to start it.	
5b	In case a Preset Cycle (MIN Level , MED Level , MAX Level) is chosen, press START to start it.	
6	1) In case the set vacuum level is lower than 99%, the pump switches off. Remove the accessory, place it on the lid of next container and press START to start a new cycle. 2) In case the set vacuum level is 99%, the pump remains on. Remove the accessory and place it on the lid of next container.	
7	Pressing STOP button at any time, it is possible to interrupt the vacuum cycle immediately.	
8	At the end of vacuum cycle, remove the accessory from the chamber.	

9.6 ALARM MANAGEMENT

9.6.1 IDEA 30 – 40 e IDEA 31 – 41



CAUTION!

In case the number of allowed cycles (preset in the machine) has been reached, at every switch-on the machine displays the pump oil change alarm "OIL".





ICON OR MESSAGE	DESCRIPTION
ALL OIL	Change the oil: the alarm appears when the 5.000 vacuum cycles have been operated.
ALL GAS	Gas failure: the alarm appears when the machine detects anomalies in inert GAS inlet system.

9.6.2 IDEA 32 HiLine – 42 HiLine



CAUTION!

When the maximum number of set vacuum cycles is reached, the icon  and the oil change message appear every time the appliance is switched on.



ICON OR PICTOGRAM	DESCRIPTION
	Cool the product: the alarm appears when the set vacuum level cannot be reached, due to the too high temperature of the product to be packed
	Operate the pump dehumidification cycle H2OUT: The alarm appears, when the machine detects a decrease of efficiency, due to the humidity absorbed by the pump.
	Gas failure: the alarm appears when the machine detects anomalies in inert GAS inlet system.
	Change the oil: the alarm appears when the 5.000 vacuum cycles have been operated.
	In case of pump overheating, all functions stop automatically and the alarm message appears.





WARNING!

If a thermal safety alarm is triggered, switch the machine off and wait for about 15 minutes until it cools down. If the alarm persists once the machine is switched on again, switch the machine off and disconnect it from the mains. Contact your authorised service centre.

10 AFTER USE

- Switch the machine Off:
 - pressing  for 5" (Models IDEA 30-40 – IDEA 31-41)
 - pressing  and  once again to Switch Off (Models IDEA32 Hi-Line – IDEA42 Hi-Line)
- Clean and dry the packaging machine and the accessories used.
- When the vacuum chamber is completely dry, release the piston (pushing it backwards) and lower the lid in the rest position, in order to protect the vacuum chamber from dirt and dust.

11 VACUUM MACHINE CLEANING

- Switch the machine Off:
 - pressing  for 5" (Models IDEA 30-40 – IDEA 31-41)
 - pressing  and  once again to Switch Off (Models IDEA32 Hi-Line – IDEA42 Hi-Line).
- Remove the plug from the socket before each intervention.**
- Do not use stainless steel sponges, scrapers, abrasive, acid or aggressive materials which may irreversibly damage the surfaces, to clean the machine.
- Use a soft cloth and a mild detergent.
- Water and/or steam, could reach live parts and cause short circuit



ELECTRICAL HAZARD!

Never use running water or steam cleaning equipment: Electric shock hazard!

- Cleaning and routine maintenance, due to the user, cannot be performed by children without supervision.

11.1 EXTERNAL CLEANING

- For steel parts it is advisable to clean by following the direction of the satin finish.
- For the lid and front control panel, use a soft, clean and damp cloth.
- Do not use any solvent, alcohol, corrosive or poisonous liquids.



WARNING!

Do not remove the serial number plates during cleaning. These provide important information regarding the appliance for any technical support.



WARNING! Do not use water jets or vapour to rinse or clean the machine; avoid using water jets and vapour near the appliance. Do not spray water on the vacuum chamber suction point.

11.2 VACUUM CHAMBER CLEANING

- Wait until the sealing bar has cooled down completely.
- Remove the sealing bar by pulling it up.
- Avoid cleaning the suction point with water. Water could damage the vacuum packing machine, if sucked up.
- Clean with a soft cloth moistened with warm water. Use a mild disinfectant if necessary.
- Dry thoroughly using a soft cloth.

11.3 SEALING BAR CLEANING

- Wait until the sealing bar has cooled down completely.
- Remove the sealing bar by pulling it up.
- Clean with a soft cloth moistened with warm water.
- Dry thoroughly using a soft cloth before using the vacuum packing machine.

11.4 EXTERNAL VACUUM ACCESSORY CLEANING





- Use hot water and dish detergent.
- Rinse thoroughly.
- Dry with a clean cloth.
- Pay attention to reuse the accessory once it has completely dried.

12 OIL PUMP DEHUMIDIFICATION CYCLE (H2OUT)

The vacuum pump is the heart of the machine. It is necessary to follow some simple recommendation, to prevent pump from internal surfaces oxidation and subsequent blockage of rotor. This is caused by the presence of oxidized residues, deriving from condensation of water vapour – sucked together with the air and remaining into the pump for long:



- Always pack the product cold, possibly at 3-4°C.** The hotter the product, the shorter the foodstuff shelf-life (due to the bacteria proliferation) and the more condensation forms inside the pump, causing oxidation and severe damages.
- If the machine is used only occasionally, please perform at least 2-3 complete USER CYCLES (VAC 99% AND VAC+ 60") before packaging the products. This allows to pre-heat the oil and the evacuate the water in the pump.
- If the vacuum machine is used in catering or restaurant sector, the pump dehumidification cycle must be performed daily, at the end of working day. In other cases, it must be performed at least weekly.**
- An oil change, has to be scheduled before a long stop or a period of inactivity longer than 2 months.**

12.1 IDEA 30 - 40 - IDEA 31 - 41

Phase	Description	Image
1	Keep  pressed for 5", to turn the vacuum packing machine on.	
2	Select "H ₂ OUT" program, using UP/DOWN buttons.	
3	Lower the lid using both hands, by pressing on the corners. The vacuum cycle starts automatically.	
4	At the end of the cycle, the machine comes back to stand-by status and it is ready to start a new working cycle, as per the selected program.	
5	The dehumidification cycle, can be interrupted at any time, pressing STOP .	

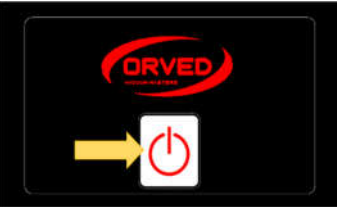
12.2 IDEA 32 Hi-Line - 42 Hi-Line

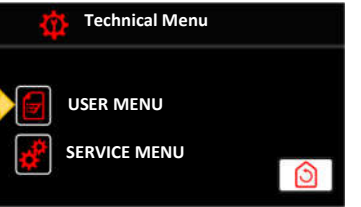
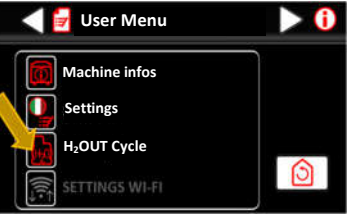
Phase	Description	Image
1	Activate the command panel by <u>double quick touch</u> on the screen. Press the STAND-BY button, to turn the machine on.	

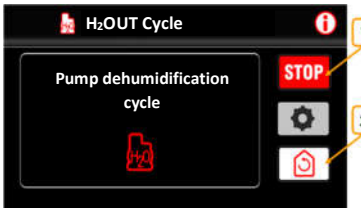
2	Select Technical Menu	
3	Select User Menu	
4	Select "H ₂ OUT" program, pressing the correspondent button	
5	Lower the lid using both hands, by pressing on the corners. The vacuum cycle starts automatically.	
6	1- Allows the user to interrupt the cycle in advance 2 - Allows the user to come back to the previous screen	
7	At the end of the cycle, the machine comes back to stand-by status and it is ready to start a new working cycle, as per the selected program.	

13 PUMP OIL DATA



WARNING!

It is important for the pump oil (specific for food vacuum applications and FDA certified) to always be kept in optimal conditions: fluid and clean, i.e. free from grit and watery parts.

Check the oil level periodically: if the vacuum machine is used in catering or restaurant sector, the pump dehumidification cycle must be performed daily, at the end of working day. In other cases, it must be performed at least weekly

- 1) **The oil must be changed according to the workload, in any case every 6 months, or once the number of cycles programmed has been reached** and on the machine display appears OIL.
Contact the service center to perform the oil change.
At every oil change, replace the exhaust filter, too.
- 2) **It is necessary to change oil before an inactivity time longer than two months.** Doing so, all oxidized residues and liquids, remained in the oil tank during the inactivity time, will be drained together with the exhaust oil.
- 3) **The room temperature should not fall below than +10°C, to avoid the pump oil thickening.** Better oil fluidity facilitates the starting of cold pump.

14 SCHEDULED ROUTINE MAINTENANCE

Implementing the scheduled maintenance regularly, as described further on in this manual, minimises and/or eliminates potential faults and interference and increases the machine lifetime significantly. Failure to perform regular maintenance can lead to significant repair costs, and in certain cases, render the guarantee null and void. Furthermore, respecting the recommendation, a good hygienic level is guaranteed.

To carry out cleaning and routine maintenance operations safely, follow the regulations listed below:



ELECTRICAL HAZARD! If the power supply cable is damaged, it must be replaced.



ELECTRICAL HAZARD! The power sources must be disconnected before cleaning, disinfecting, performing maintenance and/or repairing any component of the appliance (Disconnect the electrical plug from the mains).



WARNING!

Always use suitable preventive measures and protective devices (gloves, etc.) for any maintenance, handling, installation and cleaning operations.



WARNING!

Only qualified technicians must perform maintenance or access live parts of the machine.

Contact a Technical Support Centre authorised by the manufacturer for any repairs. Only original spare parts must be used and requested.

Do not perform maintenance yourself where the intervention of a qualified technician is indicated in the manual.

Do not touch the machine with bare, damp or wet hands or feet.

Do not insert screwdrivers, kitchen instruments or anything similar between the guards, openings and moving parts of the machine,

After completing the work, detach the piston by pushing it toward the rear and lower the lid to the resting position. This protects the vacuum chamber from dust and dirt.

MACHINE PART	INTERVENTION	FREQUENCY					INTERVENTION PERFORMED	
		1-G	1-S	6-M	1-A	4-A	USER	SERVICE CENTER
Pump	Check the oil level and colour; top-up if necessary or replace, if the colour is too dark or whitish (contact a specialised service centre).	X					O	Oil top-up or replacement.
Pump	Operate a pump heating cycle for at least 5 minutes, or a pump dehumidification cycle.	X					O	
Power cord	Verify its integrity; replace if defective	X					O	Replacement
Plexiglass lid	Verify its integrity; if there are any cracks or streaks, contact the after-sales centre to replace the lid.	X					O	Replacement
Upper bar silicone and Plexiglass lid gasket	Check that they are inserted well into the respective seats; replace if defective or worn.	X					O	Replacement
Machine and vacuum chamber	Clean impurities, oil and grease.	X					O	
Sealing bar connection	Check that it is inserted well on to the two contact pins.	X					O	
Pump	Run a pump dehumidification cycle.	X	X				O	
Sealing bar	Clean the upper part with a damp cloth. Clean the two contact pins.		X				O	
Machine, vacuum chamber, lid and fillers.	Sanitize		X				O	
Pump	Replace the pump oil			X				O
Pump	Replace the oil filter			X				O
Pump	Change the oil and replace the oil filter before a long inactivity (time longer than 2 months)							O

The present intervention has to be performed before a long inactivity period

15 TROUBLESHOOTING

ERRORE	PROBLEM	POSSIBLE CAUSES	SOLUTION
1	Machine not working.	Machine off	Switch the machine on (press STOP button for 5")
		No power supply	<ul style="list-style-type: none"> • Insert the plug in a socket (check the voltage!). • Check power cable to make sure it is intact. • Check fuse PF1 on the power board to make sure they are intact and inserted correctly (contact a service centre).
		Machine damage	Contact the authorised service center
2	Insufficient vacuum in the bag/bag does not maintain vacuum.	Bag Incorrectly positioned	Place the bag centrally on the sealing bar overpassing it about 20 mm.
		Bag perforated	Choose a thicker bag and wrap the product with cling film or soft paper.
		Insufficient sealing	Increase the sealing time

ERRORE	PROBLEM	POSSIBLE CAUSES	SOLUTION
		Defective bag	Replace the bag
		Dirty bag open	Use a new bag and avoid dirtying the opening with oil, grease, etc.
		Bag too big or too small compared to product size.	Choose a bag size suitable for product dimensions.
3	Sealing shows burns and bubbles Narrow or irregular sealing	Sealing time too long	Diminish the sealing time
		Sealing time too short	Increase the sealing time
4	Insufficient vacuum in the chamber.	Insufficient vacuum set	Increase the value level using UP and DOWN
		Insufficient vacuum pump performance	<ul style="list-style-type: none"> • Check the oil. • Check the pump exhaust filter.
		Worn cover gasket	Replace the cover gasket (contact the authorised service center)
5	Machine does not create vacuum in the chamber.	Insufficient pressure exerted on Plexiglas lid during appliance start up	Lower cover with both hands, exerting more pressure.
		For appliance provided with gas option: gas function active	Deactivate the gas function
		Pump does not work	Contact the authorised service center
6	The machine does not seal.	Dirty sealing bar contacts	Clean contacts
		Disconnected sealing bar contacts	Restore connections (contact the authorised service center)
		Broken sealing bar wire	Change the wire (contact the authorised service center)
		Defective sealing bar lifting piston	Replace the bar lifting piston (contact the authorised service center)
7	Poor sealing	Dirty sealing bar	Clean the sealing bar
		Insufficient sealing time compared to bag thickness	Increase the sealing time
		Worn Teflon band cover	Change the Teflon band
		Excessive gas percentage (close to 90%) with respect to the packaged product	Reduce the gas injection
		Upper bar silicone worn	Change the upper bar silicone
8	Insufficient gas quantity in the bag	Insufficient gas injection	Increase the gas injection
		Gas bottle pressure insufficient	Adjust the gas pressure on cylinder to 1 bar
		Gas nozzle not inserted in the bag open part	Reposition bag by inserting gas nozzle in the bag open part
		Gas bottle valve or pressure reducer closed	Open gas bottle valves and adjust pressure reducer to 1.0 bar
9	Lid opens during GAS cycle.	Gas volume too high	Reduce the GAS injection
10	Vacuum cannot be created in containers	Container lid badly positioned or lid valve open	Reposition the container lid, making sure the gasket is in good condition and inserted in its seat and the suction valve on the lid is in the open position.
11	Plexiglass lid does not close	Worn cover gasket	Replace the cover gasket
		Hinges misalignment	Adjust the cover hinge (contact the authorised service center)

ERRORE	PROBLEM	POSSIBLE CAUSES	SOLUTION
		Damaged gas spring	Replace the gas spring (contact the authorised service center)

16 INSTALLATION

16.1 SAFETY INSTRUCTIONS

This manual is an integral part of the product and provides all indications necessary for correct installation, use and maintenance of the appliance.



The user and installer must carefully read and always refer to this manual; Moreover, it must be kept in a place that is known and easily accessible for all authorized operators (instalator, user, maintainer)

Do not touch the machine with bare, damp or wet hands or feet or without suitable protections (gloves and shoes).

Do not insert screwdrivers, kitchen instruments or anything similar between the guards, openings and moving parts of the machine.

The appliance is only intended for the use which it was designed for, i.e. for vacuum packaging foodstuffs.

All other uses shall be considered improper and potentially hazardous.

The manufacturer declines any responsibility and any warranty obligation for any damage to appliances, persons or properties, due to:

- Installation not correct and/or not compliant with the current regulations;
- Modifications or interventions not specific for the machine model;
- Use of non-original spare parts or parts non-specific for the model;
- Failure to comply, even partially, with the instructions in this manual;
- Non-compliance, during the installation, of the accident prevention regulations and the current laws.

16.2 INTRODUCTION



Installation must be carried out by authorized and specialized personnel only, following strictly instructions and provisions in this manual.

- Before installing the appliance, make sure any pre-existing electrical systems comply with the law and correspond to the specifications shown on the ID plate of the appliance being installed (V, kW, Hz, and available power).
- The installer must also check for any fire prevention.
- The Manufacturer declares the conformity to European current regulations.
- Before carrying out any operation, make sure the appliance is disconnected from the mains
- Do not pull the power cord, to disconnect the machine.



CAUTION! Handling of the machine must be performed using protective gloves and always by two persons.

All components of the packaging must be disposed of according to the regulations in force in the country where the equipment is being used. In any case nothing must be disposed of into the environment.

CAUTION! The components of the packaging may be potentially hazardous for children and pets. Make sure they do not play with them!

16.3 NAMEPLATE DATA

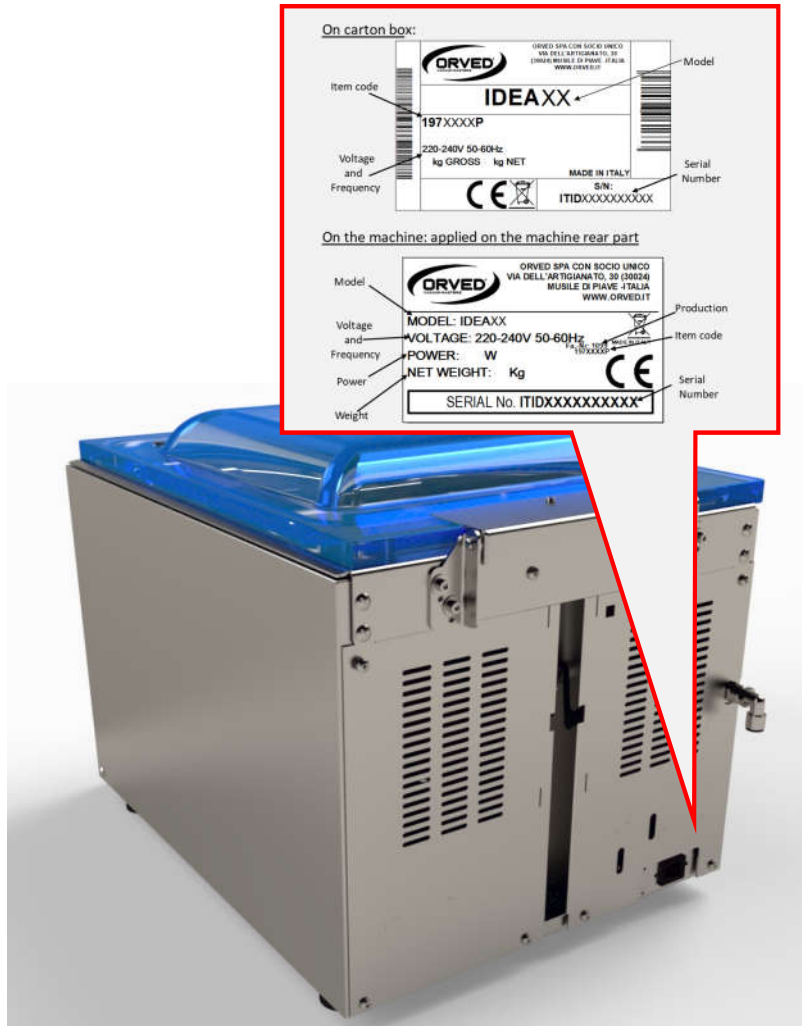

16.4 TRANSPORT AND HANDLING

The appliance can be loaded and unloaded from the transport means using suitable equipment or two persons.



WARNING! The vacuum pump contains oil. Always keep the packaging and appliance in a horizontal position to prevent the oil from leaking out of the pump.

All necessary precautions must be adopted when handling the machine to avoid it being damaged, and to avoid injury or damage to persons or property, abiding by the instructions on the packaging.



16.5 INSTALLATION

1) Check the environmental conditions: room temperature and air exchange.

The room temperature of the workplace must be between +10°C and +35°C. There must be a suitable air exchange in the installation place.

2) Check that the electrical specifications indicated on the ID plates correspond with the existing electrical system.

3) Place the machine on a flat, stable surface, able to withstand the load.



WARNING! The appliance must be positioned in such a way that it is accessible from all sides. Do not obstruct passageways, escape or service routes with the machine. Do not position the appliance in front of emergency exits or doors.

Make sure the machine is properly ventilated, leaving a gap of at least 10 cm all around it. The ventilation slots must be kept free and unobstructed in order to maintain the normal pump temperature.

4) Check the pump oil level.

- Check the correct level through the opening on the rear side, as shown.
- The most recommended level corresponds with the centreline of the inspection window.



WARNING! Never start the machine in case there is no oil in the pump!



5) Connect the machine to the electricity network.

- Before installing the appliance, make sure any pre-existing electrical systems comply with the law and correspond to the specifications shown on the ID plate of the appliance being installed (V, kW, Hz, and available power).
- The appliances are supplied with a power cable 200 cm long with standard Schuko 16A plug; the outlet must have a 10A fuse and must be easily accessible.



ELECTRICAL HAZARD!

The phase inversion in the three-phase machines must only be performed by qualified technicians. Make sure the mains to which the machine shall be connected to has a suitable and efficient earthing system. Verify that the power cable is not damaged or stuck., Contact a qualified technician, in case it must be replaced. Only qualified technicians must have access live parts. Insert and remove the plug by pulling the plug itself and not the wire.

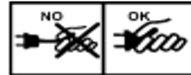

WARNING!

Make sure the plug is accessible even after the unit has been installed!
If the appliance plug is not easily accessible, the power mains must be equipped with devices for complete disconnection, with a gap between the contacts allowing complete disconnection in category III overvoltage conditions. If the entire length of the cable is not used, DO NOT roll it up but leave it free and make sure it does not obstruct or endanger passers-by.
Make sure the power cable does not come into contact with any liquids, sharp or hot objects and corrosive substances.
Do not allow children or animals to play with the power cable.

6) How to connect the Gas bottle

(per IDEA31 – IDEA 41 e IDEA 32 HiLine – IDEA 42 HiLine)

Use a suitable pipe Ø10mm, grafting it through the quick coupling on the rear, to connect the appliance to the gas bottle. Press the quick coupling green ring and insert the pipe. Adjust the inlet pressure of reducer supplied together with the bottle, between 0,5 and 1 bar.



WARNING!

Contact the Food Gas supplier, to require the gas mix most responding to your needs and the pressure reducer. Strictly comply with the gas manufacturer's instructions for proper use of the gas cylinders and gas pressure reducers.
Use a suitable pipe, to connect the gas bottle to the vacuum machine. The most common pipe is external Ø 10mm.
Use hose clamps to fix properly the pipe to the pressure reducer. Use only nitrogen (N₂), carbon dioxide (CO₂), nitrogen and carbon dioxide mixtures (N₂ and CO₂) or other inert gas mixtures. Do not use oxygen (O₂), other explosive or flammable gases, gas mixtures containing oxygen (O₂) or other explosive, flammable, or not suitable for foodstuff packing gases.
Fix the gas bottles firmly, to avoid them to overturn.

7) Clean the vacuum chamber and lid before use.

8) Check the absorption using an ammeter.

9) Run at least one complete vacuum packaging cycle for bags.

10) Inform the client of the exact use of the appliance, with specific reference to the use and requirements of the client themselves.

17 MAINTENANCE



WARNING!

Do not replace the Teflon when the bar is still hot, due to the risk of burns!
Remove always the plug from the socket before any maintenance intervention.



DANGER!

It is prohibited to remove the guards and safety devices in order to carry out maintenance operations. Orved S.p.A. declines all liability for accidents due to non-compliance with the above-mentioned obligation.

WARNING!

Always use suitable preventive measures and protective clothing (gloves, etc.) for any maintenance and/or repairs. Only qualified technicians must perform maintenance or access live parts of the machine as specified in this chapter.
Only original spare parts must be used and requested: spare parts that are not type-approved could damage the appliance or cause physical injury.
Always cite the machine model and serial number (as per §17.3), when contact the technicians.

17.1 REPLACEMENT OF COMPLETE SEALING BAR

- Extract the sealing bar from the vacuum chamber by lifting it horizontally from the sides (Fig. 1).
- Clean the electrical contacts and the pins drill holes (B) on the sealing bar thoroughly.
- Insert the new one, making sure the bar is properly engaged with the electrical contacts (A).



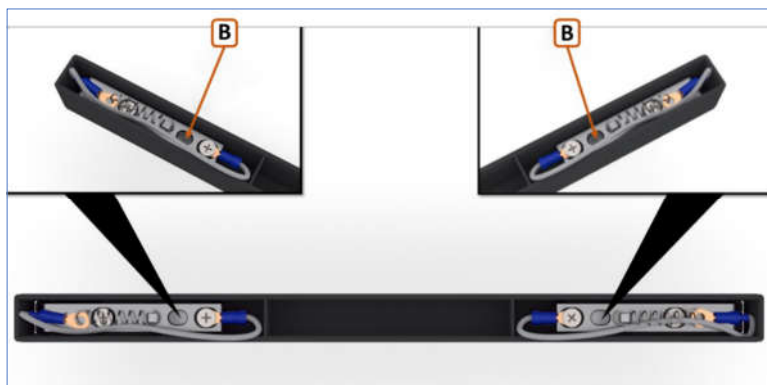

17.2 REPLACEMENT OF TEFLON BAND

Extract the sealing bar from the vacuum chamber by lifting it horizontally from the sides (Fig. 1).



Fig. 1

1) Remove the Teflon band (Fig. 2).



Fig. 2

2) Clean the sealing bar carefully, using a cloth soaked in alcohol (Fig. 3).



Fig. 3

3) Put on the new Teflon band, cutting off any excess at the ends (Fig. 4).

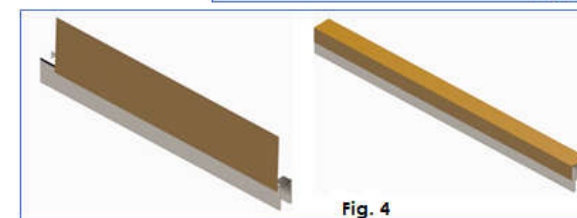



Fig. 4

4) Relocate the sealing bar in the vacuum chamber, making sure it engages correctly with the electrical contacts.

17.3 ACCESS TO THE MACHINE INTERNAL PART

1) Switch the machine off

- IDEA 30/40 e IDEA 31/41: press  per 5 secondi
- IDEA 32 HiLine/42 HiLine: press STAND-BY

2) Remove the fillers from the vacuum chamber and lower the lid to the resting position.

3) Unscrew the lower screws on the rear panel, using a cross-head screwdriver.

4) Lift the machine body using both hands (rotating it 90°) and lay it on the front (on the work table), resting it on one of the filler plates.



5) Location of the main components inside the machine:

- A) Protective lid for power board
- B) Flat connection cable, power board
- control board
- C) Vacuum pump
- D) Transformer
- E) Power supply cable
- F) Gas spring

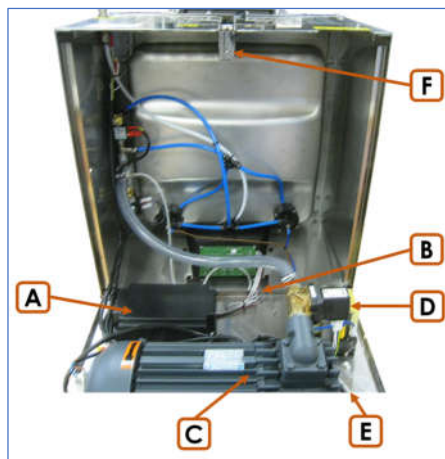

6) To close, lower the casing on the base, making sure to verify the correct positioning of the machine body as well as the position of the cables and pipes that could be cut or damaged by the machine panels.

17.4 REPLACEMENT OF PUMP OIL

- 1) Run the pump for at least 10 minutes, to make the oil fluid:
 - IDEA 30/40 and IDEA 31/41: select JAR function (pressing ▲ "+" / ▼ "-" buttons)
 - IDEA 32 HiLine/42 HiLine: select JAR MAX function and run it few times

2) Press STOP button to stop the pump.

3) Switch the machine off

- IDEA 30/40 e IDEA 31/41: press ⏻ per 5 secondi
- IDEA 32 HiLine/42 HiLine: press STAND-BY

and remove the plug from the socket.

4) Remove the fillers from the vacuum chamber and lower the lid to the resting position.

5) Open the machine body as described at § 17.3.

6) Unscrew the oil filler cap – on the pump upper part – using a hexagonal wrench (fig. 1).

7) Place a container large enough (0,5 L) close to the drainage hole (fig. 2).

Use the same wrench to undo the drain cap and leave the oil to flow into the container for about ten minutes.

8) Refasten the drain cap at the bottom of the pump and refill the pump with oil up to the correct level: in the sight-glass, the level of oil should be near the centreline (fig. 3).

9) Fasten the filling cap.

10) To close, lower the casing on the base, making sure to verify the correct positioning of the machine body as well as the position of the cables and pipes that could be cut or damaged by the machine panels.

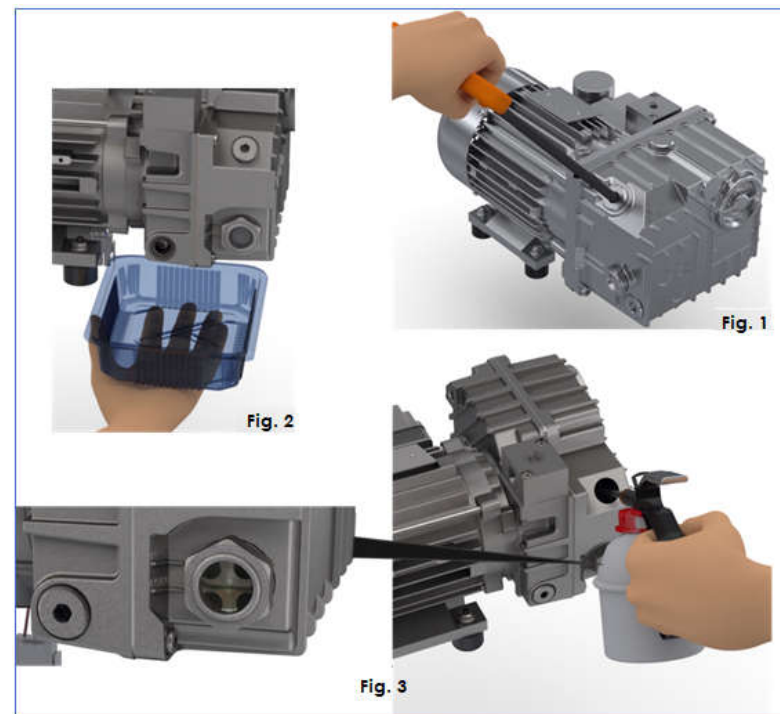

17.5 REPLACEMENT OF PUMP EXHAUST FILTER

1) Follow the procedure described at § 17.3 to access the pump.

2) Unscrew the exhaust filter cap on the pump body, using a wrench. Remove the exhaust filter. (fig. 1-2).

3) Position the new filter with the O-ring and use the same wrench to screw the new cap provided with the filter.

4) Down and close the machine body, as described at § 17.3.

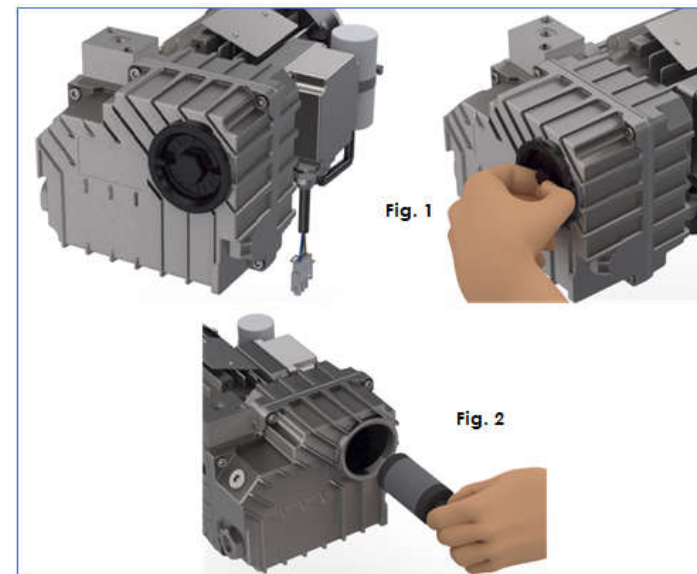

17.6 REPLACEMENT OF LID GASKET

- 1) Raise the lid.
- 2) Remove the snap ring from fastening pin (fig. 3).
- 3) Pull the pin and tilt the lid back, resting it on a stable support (fig. 4).

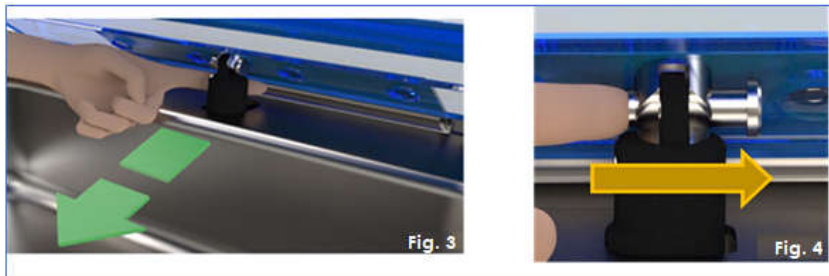

- 4) Remove the old gasket by sliding it out of its seat. Clean the seat of the gasket with neutral detergent (fig. 5).
- 5) Starting at the centre back of the seat in the cover (on the side of the hinges), fit the gasket in all the way round (fig. 6) paying attention to:
 - a) Make the two junctions precisely and clean.
 - b) Check the lip of the gasket faces outwards.
 - c) Do not stretch the gasket when fitting it in.
- 6) Re-position the gas spring, inserting the pin and locking it in place with the snap ring previously removed (fig. 7).
- 7) Run a cycle with setting the maximum vacuum level. When the maximum pressure is reached, turn off the machine at the main switch: the chamber will be pressurized with the cover down. Wait for 5 minutes with the cover closed and the chamber pressurized, to check successful operation. The lid must remain closed and adherent to the vacuum chamber.

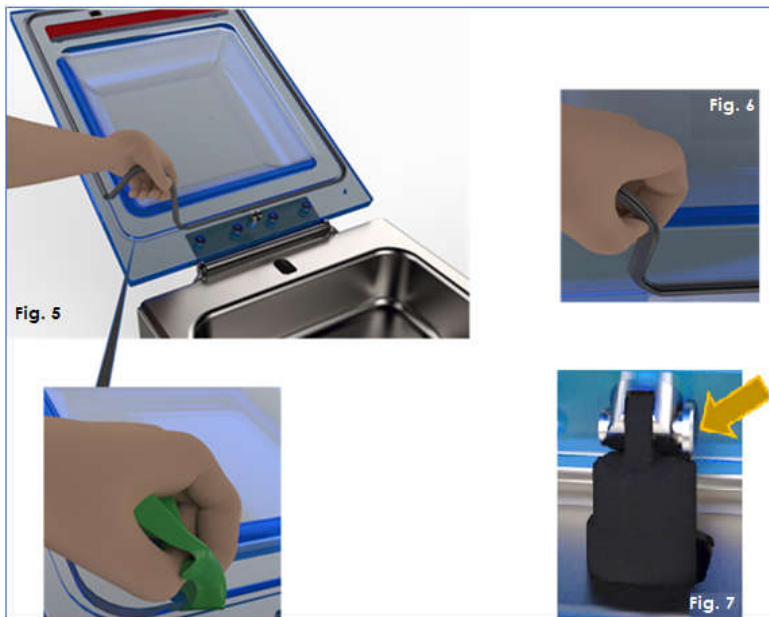

17.7 REPLACEMENT OF UPPER BAR SILICONE

- 1) Raise the lid.
- 2) Remove the silicone profile from the upper bar (fig.1).
- 3) Clean the seat thoroughly with a cloth soaked in alcohol.
- 4) Put in a new silicone profile, pushing it in a uniform manner. Do not stretch the silicone profile when fitting it in.

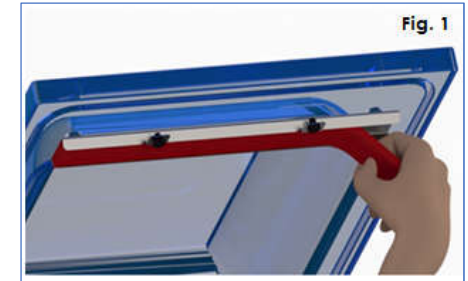

17.8 REPLACEMENT OF GAS SPRING

- 1) Remove the rear cover by pushing it upwards.
- 2) Raise the lid.



- 3) Remove the snap ring from fastening pin.
Pull the pin and tilt the lid back, resting it on a stable support.

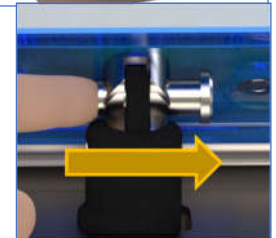

- 4) Remove the gas spring from below.



- 5) Unscrew the gas spring (A) from the sliding pin (B), by turning it counter clockwise. Screw the new gas spring to the sliding pin.
- 6) Insert the new gas spring from below.

- 7) Position the new gas spring, inserting the pin and locking it in place with the previously removed snap ring.



- 8) Reposition the rear part, pushing it downwards.



18 WIRING DIAGRAM

18.1 IDEA 30 - IDEA 40

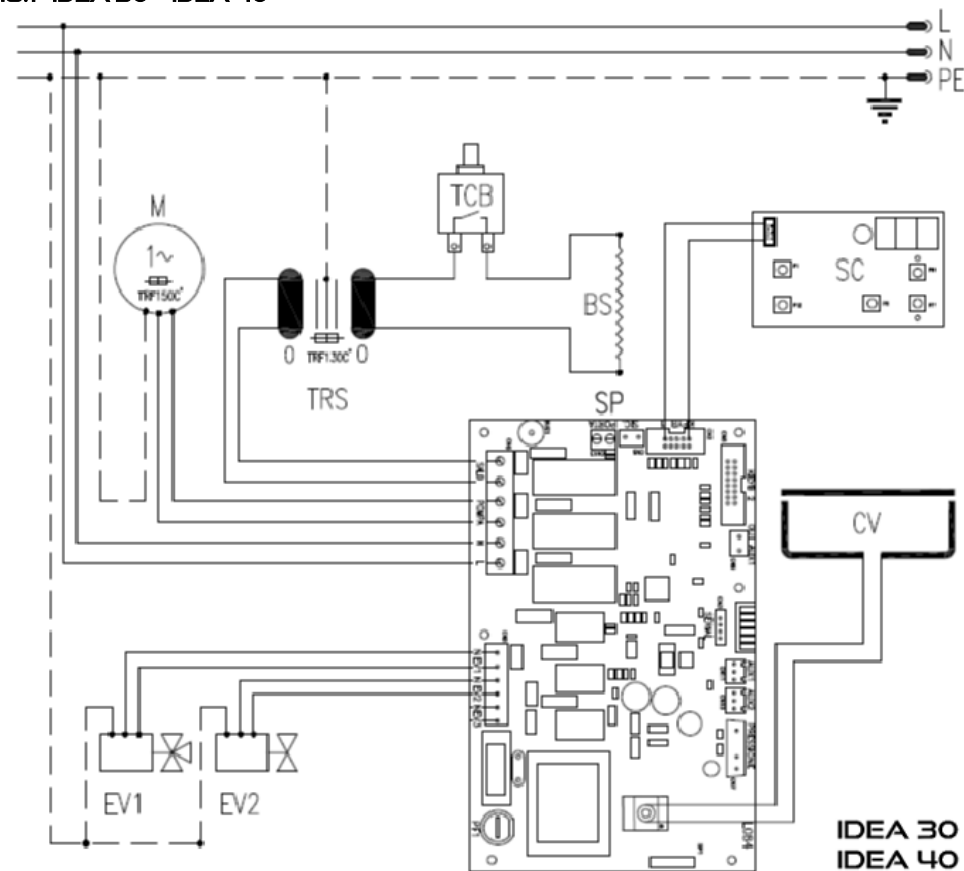

REF.	DESCRIPTION
TRS	SEALING TRANSFORMER
BS	SEALING BAR
M	VACUUM PUMP 230V AC
EV1	3 WAY SOLENOID VALVE, 230V AC, SEALING BAR ACTIVATION
EV2	2 WAY SOLENOID VALVE, 230V AC, AIR RETURN
SC	COMMAND BOARD N059
CV	VACUUM CHAMBER
SP	POWER BOARD L084 230V AC
TCB	THERMAL CIRCUIT BREAKER

18.2 IDEA 31 - IDEA 41

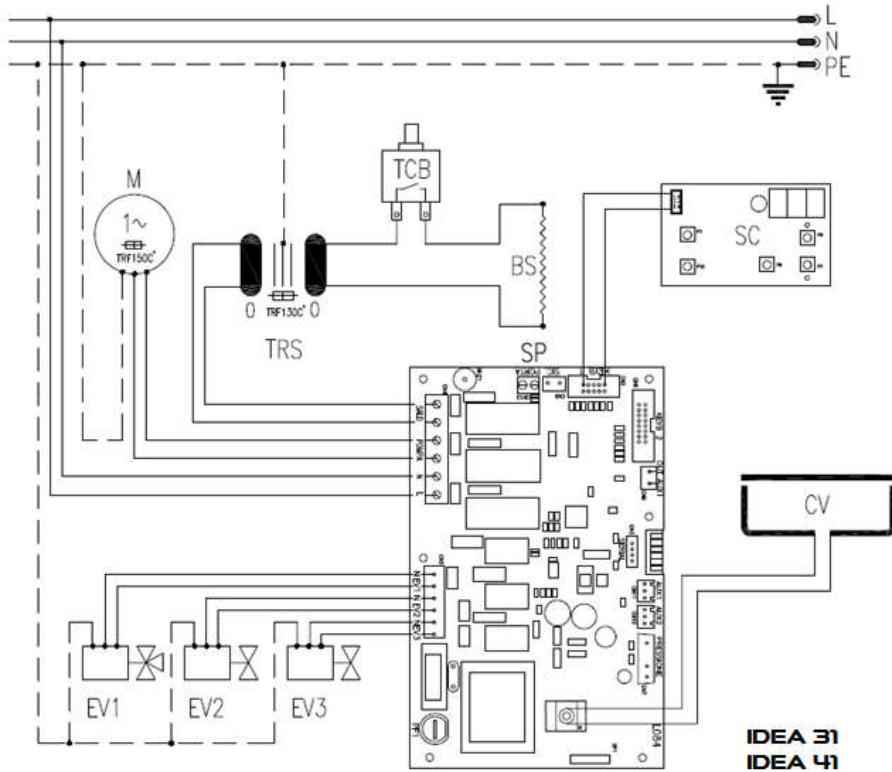

REF.	DESCRIPTION
TRS	SEALING TRANSFORMER
BS	SEALING BAR
M	VACUUM PUMP 230V AC
EV1	3 WAY SOLENOID VALVE, 230V AC, SEALING BAR ACTIVATION
EV2	2 WAY SOLENOID VALVE, 230V AC, AIR RETURN
EV3	2 WAY SOLENOID VALVE, GAS
SC	COMMAND BOARD N059
CV	VACUUM CHAMBER
SP	POWER BOARD L084 230V AC
TCB	THERMAL CIRCUIT BREAKER

18.3 IDEA 32 Hi-Line – IDEA 42 Hi-Line

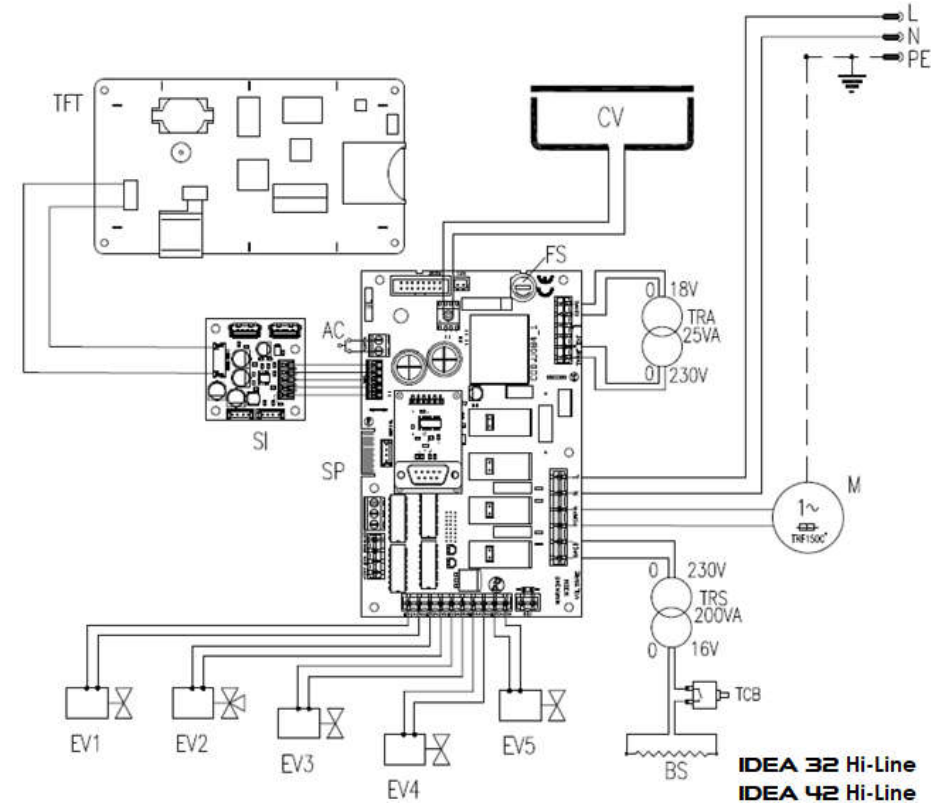

REF.	DESCRIPTION
TRA	MAIN TRANSFORMER
TRS	SEALING TRANSFORMER
BS	SEALING BAR
M	VACUUM PUMP
EV1	2 WAY SOLENOID VALVE, SOFTAIR
EV2	3 WAY SOLENOID VALVE, SEALING BAR ACTIVATION
EV3	2 WAY SOLENOID VALVE, GAS
EV4	2 WAY SOLENOID VALVE, AIR RETURN TO VACUUM CHAMBER
EV5	2 WAY SOLENOID VALVE, SUCTION VALVE
TFT	TFT DISPLAY
SI	INTERFACE UNIT U019
SP	POWER BOARD U084
CV	VACUUM CHAMBER
TCB	THERMAL CIRCUIT BREAKER
AC	CYCLE STARTUP
FS	T 6,3A FUSE

19 TECHNICAL DATA

19.1 IDEA 30 – IDEA 40

TECHNICAL DATA		IDEA 30	IDEA 40
Weight (with 2 black plates)	kg	35,5	61
Machine dimensions	mm	433x502x378	539x598x460
Power supply voltage	V	230/ 50-60Hz	230/ 50-60Hz
Maximum absorbed power	DVP pump	600W	800W
	BUSCH pump	500W	1200W
Installation		Table top	
Vacuum chamber dimensions	mm	332x335x170h	441x449x170h
Sealing bar length	mm	310	410
Maximum bag size	mm	300x350	400x450
GAS Optional		/	/
Pump mode/flow rate [m ³ /h]	DVP	LB8 / 8	MD16/16
	BUSCH	PC0008C/8	KB0020D20/20
Room temperature of use	°C	12 ÷ 40	
Relative humidity in usage room	%	10 ÷ 80	

19.2 IDEA 31 – IDEA 41

TECHNICAL DATA		IDEA 31	IDEA 41
Weight (with 2 black plates)	kg	46,5	62
Machine dimensions	mm	423x604x460	539x612x460
Power supply voltage	V	230/ 50-60Hz	230/ 50-60Hz
Maximum absorbed power	DVP pump	700W	900W
	BUSCH pump	600W	1200W
Installation		Table top	
Vacuum chamber dimensions	mm	343x434x175h	441x449x170h
Sealing bar length	mm	310	410
Maximum bag size	mm	300x400	400x450
GAS Optional		standard	standard
Pump mode/flow rate [m ³ /h]	DVP	LC12/ 12	LC20/20
	BUSCH	KB0010/10	KB0020D20/20
Room temperature of use	°C	12 ÷ 40	
Relative humidity in usage room	%	10 ÷ 80	

19.3 IDEA 32 Hi-Line – IDEA 42 Hi-Line

TECHNICAL DATA		IDEA 32 Hi-Line	IDEA 42 Hi-Line
Weight (with 2 black plates)	kg	46,5	62
Machine dimensions	mm	423x604x460	539x612x460
Power supply voltage	V	230/ 50-60Hz	230/ 50-60Hz
Maximum absorbed power	DVP pump	700W	900W
	BUSCH pump	600W	1200W
Installation		Table top	
Vacuum chamber dimensions	mm	343x434x175h	441x449x170h
Sealing bar length	mm	310	410
Maximum bag size	mm	300x400	400x450
GAS Optional		standard	standard
Pump mode/flow rate [m ³ /h]	DVP	LC12/ 12	LC20/20
	BUSCH	KB0010/10	KB0020D20/20
Room temperature of use	°C	12 ÷ 40	
Relative humidity in usage room	%	10 ÷ 80	

20 WARRANTY

It is standard for all **ORVED** products to be subjected to severe quality and functional tests before installation to protect and safeguard Client interests.

Coverage

ORVED guarantees its products against all manufacturing and processing defects and undertakes to replace any parts found to be defective by the manufacturer, free of charge.

Duration

ORVED guarantees its products for professional use, for a period of 12 (twelve) months from the sale date shown on the purchase document.

General terms

ORVED warranty terms:

- The warranty covers only the free replacement of components found to be defective by **ORVED** or any of its authorised representatives.
- ORVED** liability is limited to the sole replacement of parts found to be defective; under no circumstances shall **ORVED** respond to claims for compensation of any other type.
- Disputed and/or defective products shall be returned to **ORVED** and all transport expenses for the delivery of parts shall be entirely borne by the Client.
- Normal wear and tear of components is not covered by the warranty.
- The warranty period shall not be extended following repairs.

Invalidation of warranty

In addition to the natural expiry of the warranty period, the warranty shall be considered null and void in the following cases:

- Tampering with, alteration in any way or removal of the appliance's identification plate, without **Orved S.p.A.** having been promptly notified.
- Changes made to the device or its parts without the prior written consent of **Orved S.p.A.** In addition to invalidating the warranty, any tampering with the device or its parts shall relieve **Orved S.p.A.** of all liability for any injury/damage to persons, animals or property.
- Failure to follow the instructions in this manual.
- Use of the appliance for purposes different to those specified in this manual.
- Damage or accidents suffered by the appliance caused by external factors.
- Use, repairs and/or maintenance of the appliance by non-specialised personnel.

21 USEFUL NOTES

Purchasing date: _____

Dealer: _____

Company name: _____

Address: _____

Telephone: _____

Fax: _____

Manufacturer: Orved S.p.A. con SOCIO UNICO

Tel.: +39 0421 54387 • Fax: +39 0421 333100 • E-mail: orved@orved.it • http: www.orved.it

Nearest authorized service center:

Company name: _____

Address: _____

Telephone: _____

Fax: _____

22 SPARE PARTS

To get technical assistance and order spare parts, subscribe for free to:

<http://www.orved.it/service/>